

How to Use i-Manual

“BRAVIA” TV Features

Watching TV

Settings/Home Menu

Using Other  
Equipment/Internet

Parts Description

Troubleshooting

Bookmarks

Index

[→ i-Manual online map](#)

# BRAVIA

---

KDL-60EX720/55EX720/46EX720/40EX720/32EX720

[→ Trademark information](#)

**How to Use i-Manual**

“BRAVIA” TV Features

Watching TV

Settings/Home Menu

Using Other  
Equipment/Internet

Parts Description

Troubleshooting

Bookmarks

Index

[→ i-Manual online map](#)

## How to Use i-Manual

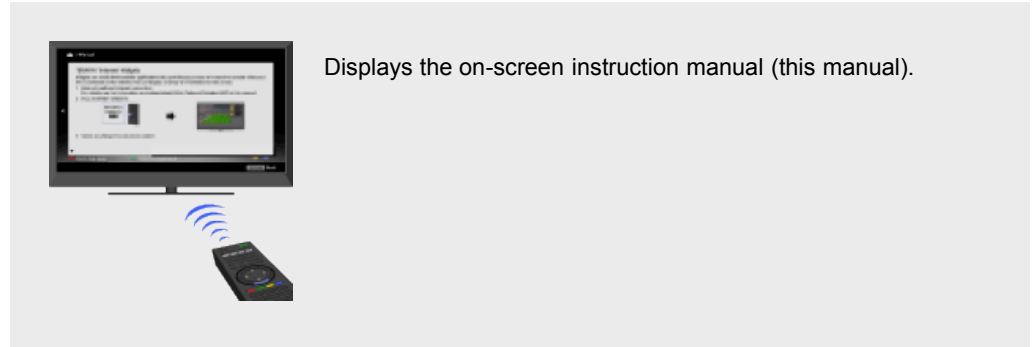

Displays the on-screen instruction manual (this manual).

Displays the on-screen instruction manual (this manual).

Please review the Setup Guide (Operating Instructions) accompanying this television for important information on usage.

### Indicators on the i-Manual screen



### i-Manual operations

To return to the previous layer/proceed to the next layer, press ◀/▶.

To step through pages, press ▲/▼.

To jump to the top page of i-Manual, press the corresponding color button.

To bookmark the page/remove bookmark, press the corresponding color button.

To operate the TV or change settings, press i-MANUAL to exit i-Manual.



- Some features can be started directly from the i-Manual. Press ⊕ to start the feature when [Use this feature] is displayed at the bottom of the screen.

[▲ Return to Top](#)

How to Use i-Manual

**"BRAVIA" TV Features**

Watching TV

Settings/Home Menu

Using Other  
Equipment/Internet

Parts Description

Troubleshooting

Bookmarks

Index

[➡ i-Manual online map](#)

## "BRAVIA" TV Features

---

[3D Feature](#)

[Presence Sensor](#)

["BRAVIA" Internet Video](#)

[Wireless LAN Ready](#)

["BRAVIA" Sync with "Control for HDMI"](#)

[Skype Ready](#)

[TrackID™/Music Search/Video Search](#)

[▲ Return to Top](#)

[How to Use i-Manual](#)

["BRAVIA" TV Features](#)

[Watching TV](#)

[Settings/Home Menu](#)

[Using Other  
Equipment/Internet](#)

[Parts Description](#)

[Troubleshooting](#)

[Bookmarks](#)

[Index](#)

[→ i-Manual online map](#)

## Watching TV

[3D Feature](#)

[Rovi On Screen Guide™](#)

[Favorites](#)

[Wide Mode](#)

[Picture Mode](#)

[Photos/Music/Videos](#)

[Twin Picture \(PIP\)](#)

[Twin Picture \(P&P\)](#)

[▲ Return to Top](#)

How to Use i-Manual

“BRAVIA” TV Features

Watching TV

Settings/Home Menu

Using Other  
Equipment/Internet

Parts Description

Troubleshooting

Bookmarks

Index

[→ i-Manual online map](#)

## Settings/Home Menu

### About the Home Menu

#### Settings

-  [Picture & Display](#)
-  [Sound](#)
-  [Preferences](#)
-  [i-Manual](#)
-  [Channels & Inputs](#)
-  [Network](#)
-  [Product Support](#)

[▲ Return to Top](#)

How to Use i-Manual

“BRAVIA” TV Features

Watching TV

Settings/Home Menu

Using Other  
Equipment/Internet

Parts Description

Troubleshooting

Bookmarks

Index

[➔ i-Manual online map](#)

## Using Other Equipment/Internet

[VCR/DVD Player](#)

[Audio System](#)

[USB Device \(e.g. Digital Camera\)](#)

[Picture Frame](#)

[HDMI Equipment](#)

[Internet/Wireless LAN](#)

[Home Network](#)

[Media Remote](#)

[PC](#)

[▲ Return to Top](#)

How to Use i-Manual

“BRAVIA” TV Features

Watching TV

Settings/Home Menu

Using Other  
Equipment/Internet

**Parts Description**

Troubleshooting

Bookmarks

Index

[→ i-Manual online map](#)

## Parts Description

Remote Control

[Top](#)

[Upper](#)

[Middle](#)

[Lower](#)

[Bottom](#)

[Rear](#)

TV Controls and Indicators

[Front](#)

[Right](#)

Terminals

[Rear](#)

[Right](#)

[▲ Return to Top](#)

[How to Use i-Manual](#)

["BRAVIA" TV Features](#)

[Watching TV](#)

[Settings/Home Menu](#)

[Using Other  
Equipment/Internet](#)

[Parts Description](#)

[Troubleshooting](#)

[Bookmarks](#)

[Index](#)

[→ i-Manual online map](#)

## Troubleshooting

[Picture Symptoms: General](#)

[Picture Symptoms: TV Program](#)

[Picture Symptoms: 3D](#)

[Picture Symptoms: Connected Equipment](#)

[Sound Symptoms](#)

[Wireless Network Connection Symptoms](#)

[Internet Video Symptoms](#)

[Internet Widget Symptoms](#)

[Home Network \(DLNA\) Symptoms](#)

[Other Symptoms](#)

[▲ Return to Top](#)



How to Use i-Manual

“BRAVIA” TV Features

Watching TV

Settings/Home Menu

Using Other  
Equipment/Internet

Parts Description

Troubleshooting

**Bookmarks**

Index

[→ i-Manual online map](#)

## Bookmarks

[How to Use Bookmarks](#)

[▲ Return to Top](#)

## Programs/Broadcasts/Channels

---

- [Age restriction](#)
- [Auto Program](#)
- [Favorite items](#)
- [Initial Setup](#)
- [Recommendations](#)

## Picture/Display

---

- [Current Time](#)
- [External input display settings](#)
- [External input selection](#)
- [Light Sensor](#)
- [Motionflow](#)
- [PC](#)
- [Picture Frame](#)
- [Picture settings](#)
- [Presence Sensor](#)
- [Pro Picture Setup](#)
- [Scene Select](#)
- [Screen settings](#)
- [Screen settings \(for PC\)](#)
- [Screen types](#)
- [Side-by-side picture display](#)
- [Two picture display](#)

## Sound

---

- [Audio out settings \(external\)](#)
- [Headphones settings](#)
- [Sound settings](#)
- [Speaker settings](#)
- [TV start-up sound](#)

## Remote Control Buttons

---

- [3D](#)
- [GUIDE](#)
- [HOME](#)
- [INTERNET VIDEO](#)
- [TrackID](#)

## Connection

---

- [Audio System](#)
- [Digital Still Camera](#)
- [HDMI device](#)
- [Home Network](#)
- [PC](#)
- [Wired LAN](#)
- [Wireless LAN Adapter \(USB\)](#)

## Other Equipment

---

- ["BRAVIA" Sync-compatible equipment](#)
- [Digital Still Camera](#)
- [Photo/music/video playback](#)
- [Slideshow](#)
- [Sync Menu](#)
- [USB Auto Start](#)

## Network

---

- DLNA-certified media server
- Internet content update
- Internet Video

- Renderer settings
- Wireless LAN

## Other

---

- Auto Shut-off
- Eco settings
- Home Menu
- Idle TV Standby
- Power Saving
- Timer

[▲ Return to Top](#)

## "BRAVIA" TV Features

---

- 3D Feature
- Presence Sensor
- "BRAVIA" Internet Video
- Wireless LAN Ready
- "BRAVIA" Sync with "Control for HDMI"
- Skype Ready
- TrackID™/Music Search/Video Search

## Watching TV

---

[▲ Return to Top](#)

- 3D Feature
- Rovi On Screen Guide™
- Favorites
- Wide Mode
- Picture Mode
- Photos/Music/Videos
- Twin Picture (PIP)
- Twin Picture (P&P)



## Settings/Home Menu

---

[▲ Return to Top](#)

### About the Home Menu

#### Settings

-  Picture & Display
  - Picture Adjustments
  - 3D Settings
  - Screen (for inputs other than a PC)
  - Screen (for PC input)
  - Pro Picture Setup
-  Sound
  - Sound Adjustments
  - MTS Audio
  - Speakers
  - Headphone/Audio Out
  - Headphone Speaker Link
  - Audio Out
  - HDMI/DVI Audio Source
  - Key Tone
  - Startup Sound
  - TV Position

-  Preferences
  - Scene Select
  - Eco
  - Clock/Timers
  - Language
  - Region
  - Closed Captions (CC)
  - Parental Lock
  - Info Banner
  - Recommendation
  - Picture Adjustments Lock
  - Initial Setup

? i-Manual

-  Channels & Inputs
  - Manage Inputs
  - Cable/Antenna
  - Auto Program
  - Add Digital Channels
  - Show/Hide Channels
  - Edit Channel Labels
  - Program Information Source
  - Analog Fine Tune
  - Video 2/Component Selection
  - HDMI Settings
  - USB Auto Start

-  Network
  - Network Setup
  - Refresh Internet Content
  - Home Network Setup

-  Product Support
  - Contact Sony
  - Signal Diagnostics
  - Automatic Software Download
  - Software Update

## Using Other Equipment/Internet

[▲ Return to Top](#)

- VCR/DVD Player
- Audio System
- USB Device (e.g. Digital Camera)
- Picture Frame
- HDMI Equipment
  - Connecting HDMI Equipment
  - Viewing from HDMI Equipment
  - “BRAVIA” Sync with “Control for HDMI”
- Internet/Wireless LAN
  - Wireless LAN Ready
  - Wired LAN
  - Browsing Websites

- [“BRAVIA” Internet Video](#)
- [Photomap](#)
- [What’s New](#)
- [Home Network](#)
  - [Connecting to a Home Network](#)
  - [Renderer](#)
  - [Display Settings for Media Servers](#)
  - [Media Server Troubleshooting](#)
- [Media Remote](#)
- [PC](#)

---

## Parts Description

[▲ Return to Top](#)

### Remote Control

- [Top](#)
- [Upper](#)
- [Middle](#)
- [Lower](#)
- [Bottom](#)
- [Rear](#)

### TV Controls and Indicators

- [Front](#)
- [Right](#)

### Terminals

- [Rear](#)
- [Right](#)

---

## Troubleshooting

[▲ Return to Top](#)

- [Picture Symptoms: General](#)
- [Picture Symptoms: TV Program](#)
- [Picture Symptoms: 3D](#)
- [Picture Symptoms: Connected Equipment](#)
- [Sound Symptoms](#)
- [Wireless Network Connection Symptoms](#)
- [Internet Video Symptoms](#)
- [Internet Widget Symptoms](#)
- [Home Network \(DLNA\) Symptoms](#)
- [Other Symptoms](#)

---

## Bookmarks

[▲ Return to Top](#)

- [How to Use Bookmarks](#)

[▲ Return to Top](#)

## Licensing Information

---

Macintosh is a trademark of Apple Inc., registered in the U.S. and other countries.

HDMI, the HDMI Logo, and High-Definition Multimedia Interface are trademarks or registered trademarks of HDMI Licensing LLC in the United States and other countries.

Ferguson Patent Properties, LLC:  
U.S. Patent No. 5,717,422  
U.S. Patent No. 6,816,141

Manufactured under license from Dolby Laboratories. Dolby and the double-D symbol are trademarks of Dolby Laboratories.

Rovi and Rovi On Screen Guide are trademarks of Rovi Corporation and/or its subsidiaries.

The Rovi On Screen Guide system is manufactured under license from Rovi Corporation and/or its subsidiaries.

The Rovi On Screen Guide system is protected by one or more United States patents of Rovi Corporation and/or its subsidiaries.

Rovi Corporation and/or its subsidiaries and related affiliates are not in any way liable for the accuracy or availability of the program schedule information or other data in the Rovi On Screen Guide system and cannot guarantee service availability in your area. In no event shall Rovi Corporation and/or its related affiliates be liable for any damages in connection with the accuracy or availability of the program schedule information or other data in the Rovi On Screen Guide system.

Blu-ray Disc is a trademark.

“BRAVIA” and **BRAVIA**, S-Force, BRAVIA Sync, and  are trademarks or registered marks of Sony Corporation.

“PlayStation” is a registered trademark and “PS3” is a trademark of Sony Computer Entertainment Inc.

DLNA®, the DLNA Logo and DLNA CERTIFIED® are trademarks, service marks, or certification marks of the Digital Living Network Alliance.

TrackID is a trademark or registered trademark of Sony Ericsson Mobile Communications AB.

Music and video recognition technology and related data are provided by Gracenote®. Gracenote is the industry standard in music recognition technology and related content delivery.

For more information, please visit [www.gracenote.com](http://www.gracenote.com).

CD, DVD, Blu-ray Disc, and music and video-related data from Gracenote, Inc., copyright © 2000-present Gracenote. Gracenote Software, copyright © 2000-present Gracenote. One or more patents owned by Gracenote apply to this product and service. See the Gracenote website for a nonexhaustive list of applicable Gracenote patents. Gracenote, CDDb, MusicID, MediaVOCS, the Gracenote logo and logotype, and the “Powered by Gracenote” logo are either registered trademarks or trademarks of Gracenote in the United

States and/or other countries.

Your BRAVIA TV is ENERGY STAR® qualified in the “Home” mode.

It meets strict energy efficiency guidelines set by the U.S.

Environmental Protection Agency and Department of Energy. ENERGY STAR is a joint program of these government agencies, designed to promote energy efficient products and practices.

Changes to certain features, settings, and functionalities of this TV (i.e. Rovi On Screen Guide, Picture/Sound, Light Sensor, Power Savings) can increase or change the power consumption.

Depending upon such changed settings, the power consumption may exceed the limits required for the ENERGY STAR qualification in the “Home” mode.



- Applicable trademark information depends on your TV model/region/country.





How to Use i-Manual

**"BRAVIA" TV Features**

Watching TV

Settings/Home Menu

Using Other  
Equipment/Internet

Parts Description

Troubleshooting

Bookmarks

Index

[→ i-Manual online map](#)

## 3D Feature

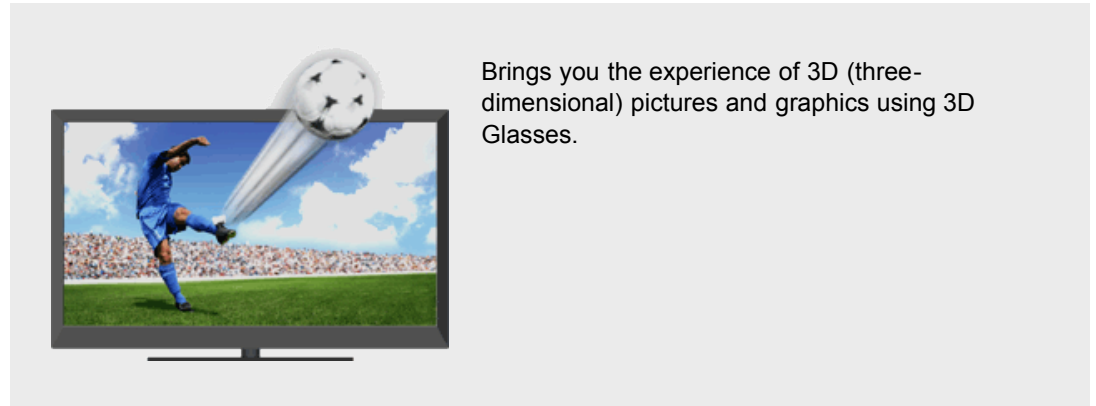

Brings you the experience of 3D (three-dimensional) pictures and graphics using 3D Glasses.

This feature lets you experience powerful 3D entertainment, such as stereoscopic 3D games and 3D Blu-ray Discs.

Turn the 3D Glasses on, then put them on to watch 3D content.

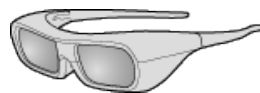

3D Glasses TDG-BR250



- 3D effect is available only when pictures are displayed in full screen.
- Additional viewers with 3D Glasses can also enjoy 3D content.
- The 3D Glasses are supplied or available as an optional accessory, depending on your TV model. In some regions/countries, the 3D Glasses may not be available.
- The 3D Glasses TDG-BR250 may not be available in some regions/countries. If unavailable, use other compatible 3D Glasses.
- If [Motionflow] is set to other than [Off], the smooth movement of the picture may be lost as the picture process to minimize screen flicker is applied. In such a case, set [Motionflow] to [Off] to display the original picture.

## Watching the following pictures in 3D

Regular 2D picture    Side-by-side picture    Over-under picture



1. Press 3D to display the 3D Menu.



2. Press 3D repeatedly to toggle through [3D Display] modes.
  - [Simulated 3D]: Displays regular 2D pictures in simulated 3D.
  - [Side-by-Side]: Displays side-by-side pictures in 3D.
  - [Over-Under]: Displays over-under pictures in 3D.
  - [Off]: Displays pictures as they are.
3. Press RETURN to exit the 3D Menu.



- Simulated 3D effect may be less pronounced with some picture sources.
- Perceived simulated 3D effect may vary from person to person.
- Simulated 3D display mode automatically switches back to 2D display mode an hour after its activation.

## Watching 3D content in 2D

1. Press 3D to display the 3D Menu.



2. Press 3D to select [Off] in [3D Display].
3. Press RETURN to exit the 3D Menu.



- The 3D display mode is automatically selected when a 3D signal is detected.
- To prevent 3D display mode from being automatically selected when a 3D signal is detected, press HOME, then select  → [Picture & Display] → [3D Settings] → [Auto 3D] → [Off].

## 3D Sync Transmitter and 3D Glasses communication range

The recommended viewing angle and distance are shown in the illustrations. To enjoy the best 3D effect, the preferred viewing position needs to be kept within the range where the 3D Sync Transmitter works.

Overhead view

Side view

45°

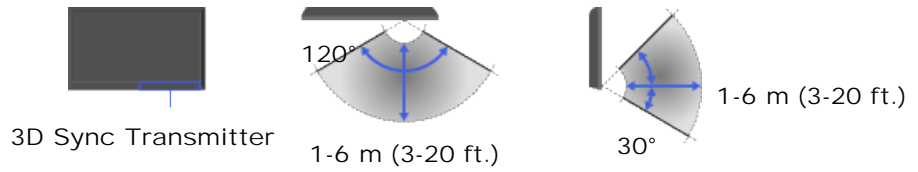

- Recommended viewing angle and distance may vary depending on the TV's location and room conditions.
- Do not put anything in front of the 3D Sync Transmitter. Doing so may affect its function.
- Signals between the 3D Sync Transmitter and 3D Glasses may be interrupted if an infrared device is used near the TV.

## 3D Menu

You can adjust the following settings from the 3D Menu.  
Press 3D, then select the desired setting → the desired option.

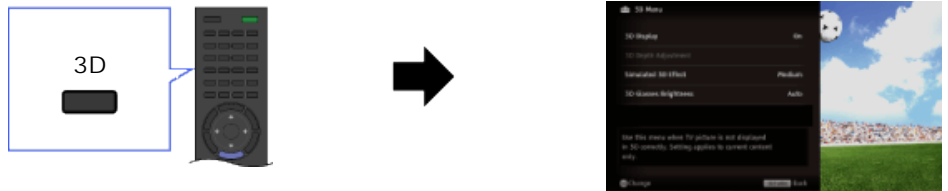

## 3D Display

When 3D pictures are displayed:

Switches between the 3D and 2D display modes.

When non-3D pictures are displayed:

[Simulated 3D]: Displays regular 2D pictures in simulated 3D.

[Side-by-Side]: Displays side-by-side pictures in 3D.



- Two near-identical pictures for 3D viewing are displayed side-by-side.

[Over-Under]: Displays over-under pictures in 3D.



- Two near-identical pictures for 3D viewing are displayed one above the other.

[Off]: Displays pictures as they are.

---

### 3D Depth Adjustment

Adjusts the depth of 3D pictures on the screen.



- Available only for content with 3D signals.
- Selecting [0] is recommended for normal use.
- 3D effect may be less pronounced depending on the settings.

---

### Simulated 3D Effect

Heightens/lessens the 3D effect when you display 2D pictures in simulated 3D.

---

### 3D Glasses Brightness

Sets the image brightness when using 3D display mode.



- By selecting [Auto], image brightness through the 3D Glasses is automatically adjusted in conjunction with the [Picture Mode] setting.

---

[▲ Return to Top](#)

How to Use i-Manual

"BRAVIA" TV Features

Watching TV

Settings/Home Menu

Using Other  
Equipment/Internet

Parts Description

Troubleshooting

Bookmarks

Index

→ i-Manual online map

## Presence Sensor

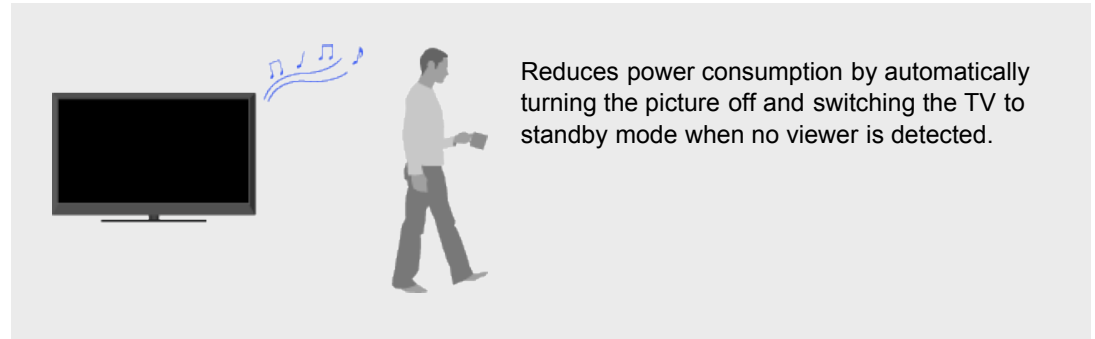

This feature reduces power consumption by monitoring a viewer presence via the built-in sensor. When no viewer is detected in front of the TV for a preset time, the picture automatically turns off, while leaving only the TV sound on. Additionally, after 30 minutes in picture off mode, the TV will switch to standby mode.

To set [Presence Sensor], press HOME, then select → [Preferences] → [Eco] → [Presence Sensor] → the desired option.

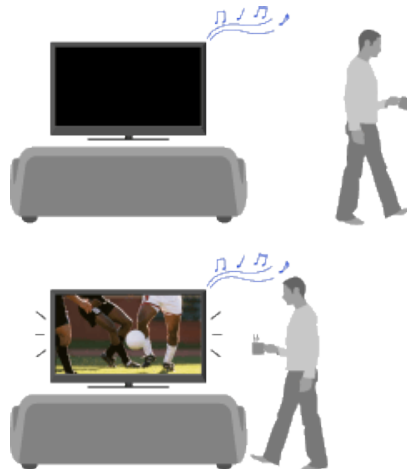

## Presence Sensor detection range

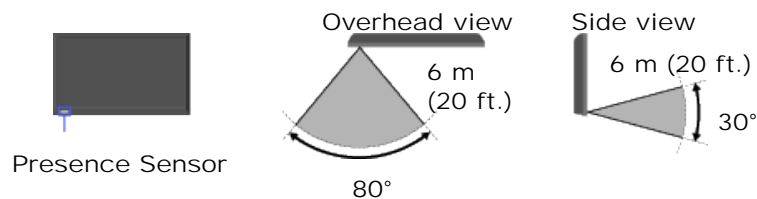

- Sensor detection range illustrated in the figure is based on normal room conditions.
- Even if a person is in front of the TV, the sensor may not detect anything if the person does not

move.

- The sensor may not work when the ambient temperature changes due to air conditioning, etc.
- The sensor is sensitive to movement from side to side and up and down and is less sensitive to the viewer's forward or backward movement.
- Sensor detection range may vary depending on the TV's location, room temperature and lighting conditions.

[▲ Return to Top](#)

How to Use i-Manual

"BRAVIA" TV Features

Watching TV

Settings/Home Menu

Using Other  
Equipment/Internet

Parts Description

Troubleshooting

Bookmarks

Index

→ i-Manual online map

## "BRAVIA" Internet Video

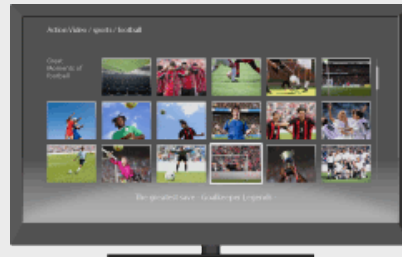

Brings videos, movies and much more through the broadband Internet connection to your TV.

This feature serves as a gateway to Internet content, delivering a variety of on-demand entertainment straight to your TV. You can enjoy video content, including movies and cartoons.

1. Make a broadband Internet connection.  
For details, see the information on wireless/wired LAN in "Internet/Wireless LAN" in this manual.
2. Press INTERNET VIDEO, then select [BRAVIA Internet Video] → the desired service.

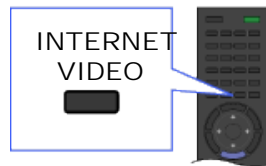

3. Highlight the desired content, then press .



- If you experience difficulties with this feature, check that the Internet connection is set up properly.
- Information about the highlighted icon appears in the information banner.
- The interface to Internet content depends on the Internet content providers.
- Services block video content based on the [Parental Lock] setting of the TV. Some service providers do not support this function.
- To update "BRAVIA" Internet Video content services, press HOME, then select  → [Network] → [Refresh Internet Content].

## Seeking forward/backward in video content

Press the buttons on the remote control that correspond with the control indications on the screen.



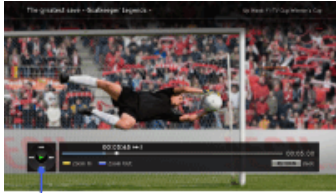

Control indications

[▲ Return to Top](#)

---

Copyright 2011 Sony Corporation

How to Use i-Manual

**"BRAVIA" TV Features**

Watching TV

Settings/Home Menu

Using Other  
Equipment/Internet

Parts Description

Troubleshooting

Bookmarks

Index

[→ i-Manual online map](#)

## Wireless LAN Ready

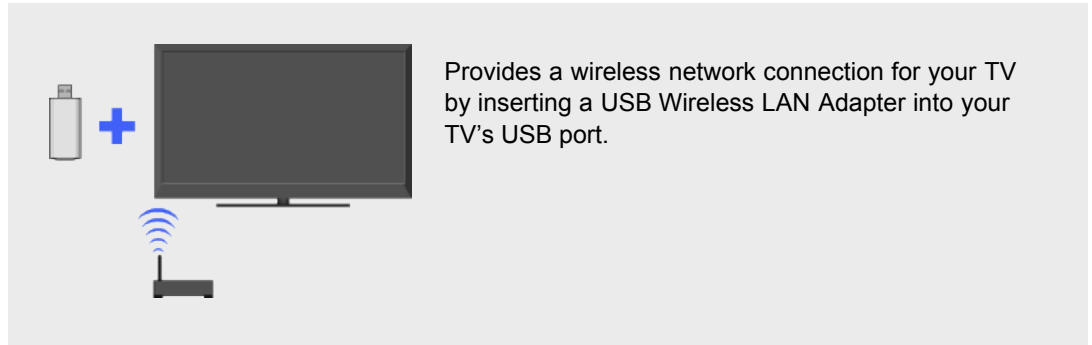

By inserting the USB Wireless LAN Adapter UWA-BR100 (as of December 2010) into your TV's USB port, you can create a wireless network connection.

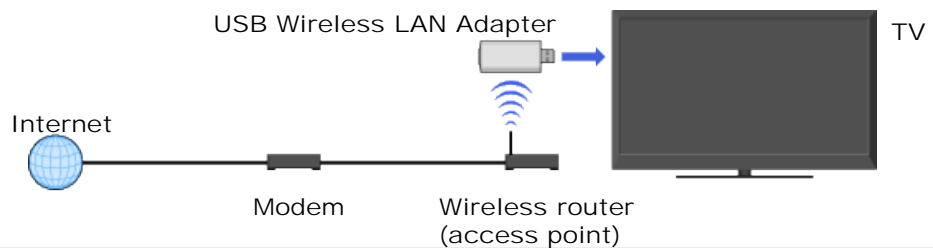

- The USB Wireless LAN Adapter is supplied or available as an optional accessory, depending on your TV model. In some regions/countries, the USB Wireless LAN Adapter may not be available.
- If your TV has two USB ports, be sure to connect the USB Wireless LAN Adapter to the upper USB port.

## Connecting to your wireless LAN

1. Set up your wireless router (or access point).  
For details, refer to the instruction manual of your wireless router (or access point).
2. Check your wireless LAN environment using the following chart.



- Tip for smooth video streaming: Change the setting of your wireless router (or access point) to 802.11n and 5GHz if possible. For details on how to change the setting, refer to the instruction manual of your wireless router (or access point).

Do you use a secure wireless LAN?

**YES** →

Do you use a wireless router (or access point) compatible with Wi-Fi Protected Setup (WPS)?

**YES** →

If your wireless router (or access point) has a WPS button, proceed to TYPE 1.

If your wireless router



(or access point) has a PIN code, proceed to TYPE 2.
If your wireless router (or access point) has both a WPS button and PIN code, proceed to TYPE 1.

### TYPE 1: Secured network using the WPS button

---

1. Check the WPS button location on your wireless router (or access point) and verify how to use it.
2. Press HOME, then select  → [Network] → [Network Setup].  
The start-up screen appears.
3. Select [Wireless Setup] → [WPS (Push Button)], then follow the on-screen instructions.

### TYPE 2: Secured network using the PIN code

---

1. Press HOME, then select  → [Network] → [Network Setup].  
The start-up screen appears.
2. Select [Wireless Setup] → [WPS (PIN)], then follow the on-screen instructions.

### TYPE 3: Secured network using SSID and security key

---

1. Check the SSID (wireless network name) and security key (WEP or WPA key) of your wireless router (or access point).  
If you do not know them, refer to the instruction manual of your wireless router (or access point).
2. Press HOME, then select  → [Network] → [Network Setup].  
The start-up screen appears.
3. Select [Wireless Setup] → [Scan].
4. Select a network from the list of scanned wireless networks, then follow the on-screen instructions.

### TYPE 4: Unsecured network using only SSID

---

1. Check the SSID (wireless network name).  
If you do not know the SSID, refer to the instruction manual of your wireless router (or access point).
2. Press HOME, then select  → [Network] → [Network Setup].  
The start-up screen appears.
3. Select [Wireless Setup] → [Scan].
4. Select a network from the list of scanned wireless networks, then follow the on-screen instructions.

[▲ Return to Top](#)

How to Use i-Manual

"BRAVIA" TV Features

Watching TV

Settings/Home Menu

Using Other  
Equipment/Internet

Parts Description

Troubleshooting

Bookmarks

Index

[→ i-Manual online map](#)

## "BRAVIA" Sync with "Control for HDMI"



Helps communicate with "BRAVIA" Sync-compatible equipment (e.g. BD player, AV amplifier) using HDMI CEC.

With the "Control for HDMI" function, "BRAVIA" Sync helps communicate with "BRAVIA" Sync-compatible equipment using HDMI CEC (Consumer Electronics Control).

### Activating "Control for HDMI" ("BRAVIA" Sync)

1. Press HOME, then select → [Channels & Inputs] → [HDMI Settings] → [Control for HDMI] → [On].
2. Activate "Control for HDMI" on the connected equipment.  
For details, refer to the instruction manual of the connected equipment.



- "Control for HDMI" ("BRAVIA" Sync) is only available for the connected Sony equipment that has the "BRAVIA" Sync logo or is compatible with "Control for HDMI."
- When specific Sony equipment compatible with "Control for HDMI" ("BRAVIA" Sync) is connected and powered on, and [Control for HDMI] is set to [On], "BRAVIA" Sync is automatically activated on the equipment.

### Available "BRAVIA" Sync operations

#### BD/DVD player

- Automatically turns the "BRAVIA" Sync-compatible equipment on and switches the input to that equipment when you select it from the Home Menu or Sync Menu.
- Automatically turns the TV on and switches the input to the connected equipment when the equipment starts to play.
- Automatically turns the connected equipment off when you turn the TV off.
- Controls menu operation ( ) , playback (e.g. ) and channel selection of the connected equipment through the TV's remote control.

#### AV amplifier

- Automatically turns the connected AV amplifier on and switches the sound output from the TV speaker to the audio system when you turn the TV on. This function is only available if you have previously used the AV amplifier to output TV sound.

- Automatically switches the sound output to the AV amplifier by turning the AV amplifier on when the TV is turned on.
- Automatically turns the connected AV amplifier off when you turn the TV off.
- Adjusts the volume (VOL +/-) and mutes the sound (MUTING) of the connected AV amplifier through the TV's remote control.



- When connecting a digital audio system that is compatible with Audio Return Channel (ARC) technology, connect to HDMI IN 1 with an HDMI cable. If connecting a system that is incompatible with "Control for HDMI" or Audio Return Channel, an additional audio connection via DIGITAL AUDIO OUT (OPTICAL) is necessary.

---

### Video camera

- Automatically turns the TV on and switches the input to the connected video camera when the connected video camera is turned on.
- Automatically turns the connected video camera off when you turn the TV off.
- Controls menu operation (←/→/↑/↓), playback (e.g. ▶, ■) and channel selection of the connected equipment through the TV's remote control.

---

## Controlling "BRAVIA" Sync-compatible equipment

You can control "BRAVIA" Sync-compatible equipment by the TV's remote control. Press SYNC MENU, then select [HDMI Device Selection] → the desired equipment.

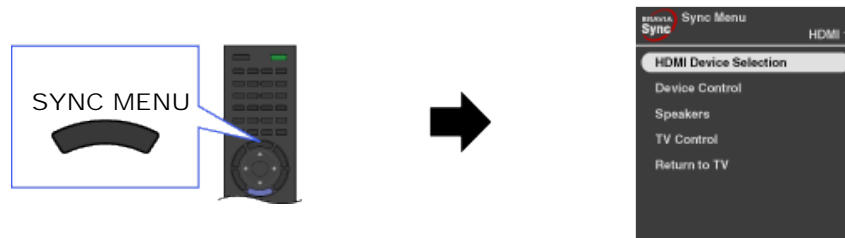

- Any "BRAVIA" Sync-compatible equipment (except audio system) is listed as a new input source under [Inputs] in the Home Menu.

---

## Sync Menu

Sync Menu provides the following items.

Press SYNC MENU, then select the desired item.

---

### HDMI Device Selection

Enables selection of "BRAVIA" Sync-compatible equipment to control by the TV's remote control.

---

### Device Control

Displays the menu, options and title list of the connected equipment, or turns the equipment off.

---

### Speakers

Switches the speaker output between the TV and connected audio equipment.

---

### TV Control

Displays the menu and options of the TV, or shows/hides the display items on the TV screen.

Return to TV  
Returns to the TV tuner.

---

[▲ Return to Top](#)

---

Copyright 2011 Sony Corporation

How to Use i-Manual

**"BRAVIA" TV Features**

Watching TV

Settings/Home Menu

Using Other  
Equipment/Internet

Parts Description

Troubleshooting

Bookmarks

Index

→ i-Manual online map

## Skype Ready



Enjoy free Skype™-to-Skype voice and video calls to friends and family anywhere in the world with a compatible TV webcam and an Internet connection.

Skype allows you to make free video and voice calls from the comfort of your living room. Enjoy widescreen video calls by connecting the optional Camera and Microphone Unit CMU-BR100. Note that a stable Internet connection is also required.

You can use your existing Skype account or create a new one on your TV. Select [Skype] in the [Applications] menu, connect your TV camera, log in and start enjoying widescreen video calls from your living room.

If you want to call a friend who is not on Skype, you could make great savings by calling them on their landline or mobile using Skype.



- To use this feature, the TV has to be connected to the Internet.
- For more information on Skype, please visit <http://www.Skype.com/>
- No emergency calls. Skype is not a replacement for your telephone and can't be used for emergency calling.
- Skype may not be available while some other applications are being used.
- Use of a wireless network connection may cause audio/image degradation.
- Connect the optional Camera and Microphone Unit directly to the TV's USB port. Do not connect it via a USB hub.
- Audio and video calls are free to other people on Skype. For other Skype services such as low cost calls to mobile phones and landlines, Skype Credit or a subscription is required.
- Skype is a trade mark of Skype Limited or its related companies. This product / application has not been checked, verified, certified or otherwise approved or endorsed by Skype Limited, Skype Communications S.a.r.l. or any of their related companies.
- This product includes SkypeKit Version 3. Copyright 2003-2010, Skype Limited. Patents Pending.

Skype, associated trade marks and logos and the “S” symbol are trade marks of Skype Limited.

- The sound quality of the microphone may deteriorate in a noisy environment.

## How to use Skype on your TV

---

### Using Skype while watching TV

With the menu screen displayed on the right, you can operate Skype even while watching TV.

It is easy to start a Skype call by selecting a contact from your contact list or history.

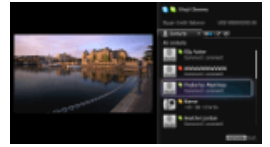

### Receiving a call while watching TV

A message window notifies you of an incoming call, allowing you to answer the call.



## Connecting the optional Camera and Microphone Unit CMU-BR100

---

Attach the camera to the top (or rear) of the TV, then connect the USB cable to the TV's USB port.

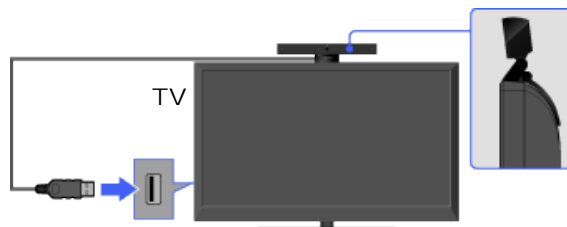

- The Camera and Microphone Unit captures your voice.

## Creating your Skype account (required only if you have no account yet)

---

1. Press HOME, then select  → [Skype].

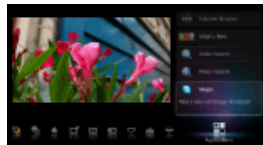





2. Follow the on-screen instructions to create your account.

## About the status icons in the Home Menu

---

When [Skype] in [Applications] of the Home Menu is selected, a status icon appears next to [Skype], indicating the status of your Skype account. Each status icon indicates as follows:

 : Auto Sign in error,  : Online,  : Away,  : Do Not Disturb,  : Invisible

## Making a call

---



Voice and video calls can be initiated in a couple of different ways.

---

#### From your Skype contact list

Select a contact or phone number from the contact list.  
Press HOME, then select  → [Skype] → [Contacts] → the contact/phone number to call → [Video Call]/[Voice Call].

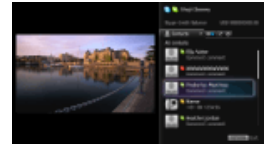

- You can add contacts to the contact list from the call history list, after dialing a phone number, or finding a contact from the Skype directory.
- Status Icons: A status icon is displayed next to your contacts, so you know if they are available to have a conversation. The list below indicates their availability:  
✔ : Online, ☾ : Away, 🚫 : Do Not Disturb, ✖ : Offline, ➡ : Offline (with call forwarding enabled), 📞 : Phone contact, 📧 : Offline (with voice mail enabled), ⚠ : Pending authorization

---

#### Using the call history list

Select a contact or phone number from the call history list.  
Press HOME, then select  → [Skype] → [History] → the contact/phone number to call → [Video Call]/[Voice Call].

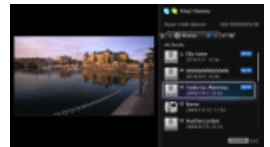

- The icons in the history list indicate the following:  
⬇ : Missed call, ☎ : Incoming call, ☎ : Outgoing call, 📞 : Voice mail, ⚠ : Authorization request

---

#### Dialing a phone number

- Enter a phone number using the dial pad.
1. Press HOME, then select  → [Skype] → [Tools] → [Call Phone Number].
  2. Enter a phone number, then select [Call].



---

#### Adding new Skype friends to your contact list

- Search the Skype directory by entering the Skype name, full name or e-mail address of the person to call.
1. Press HOME, select  → [Skype] → [Tools] → [Find Contacts].
  2. Enter a Skype name, full name or e-mail address, then select [Search] → the contact/phone number to call → [Video Call]/[Voice Call].

---

#### Receiving a call

You can receive a call even while watching TV or using other applications.

When the following screen notifies you of an incoming call, select [Video Call] or [Voice Call] to answer.





- While using another application, an incoming call notification is displayed using the full screen.

## Features/options

---

Use the menu bar at the bottom of the screen for call options.



Menu bar



- For the best audio quality during a Skype call, use the speakers that are built into the TV instead of using an external audio system. To use the TV speakers, press **OPTIONS**, then select **[Speakers] → [TV Speakers]**.
- When the other party is displayed in full screen, you can show/hide the menu bar by pressing **DISPLAY**.

[▲ Return to Top](#)

How to Use i-Manual

"BRAVIA" TV Features

Watching TV

Settings/Home Menu

Using Other  
Equipment/Internet

Parts Description

Troubleshooting

Bookmarks

Index

→ i-Manual online map

## TrackID™/Music Search/Video Search



Searches for information about music heard from your TV, video, and related information by exploring the database.

### TrackID™

This feature searches for information about music heard from your TV. You can obtain information about music played on the current program, external input, connected USB storage device, etc.

1. While music is playing, press TrackID.  
A message appears displaying the number of search results. The search results are stored in [Bookmarks].

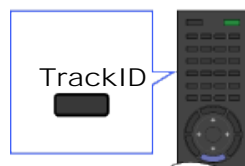

2. Press  $\odot$  to launch the [Music Search] application for detailed information.
3. Select a search result in the list.



- To use this feature, the TV has to be connected to the Internet. After making Internet connection and completing [Network Setup], perform [Refresh Internet Content]. Press HOME, then select  $\square$  → [Network] → [Refresh Internet Content].
- The search may fail if dialog or sound effects of the current program are too loud.
- Information may not be obtainable depending on the music.

### Music Search/Video Search

[Music Search] extends a TrackID™ search by exploring the database. You can also start a new search for information about other music by entering a keyword (track title, album name and/or artist name).

[Video Search] allows you to search for information about videos by entering a keyword (video title or cast) and exploring the database. You can use [Video Search] in the same manner as [Music Search].

To launch the application and start a new search, follow the procedure below.

1. Press HOME, then select  → [Music Search] or [Video Search].
2. Select [Text Search] → [New Search].



3. For [Music Search]: Enter a keyword.  
For [Video Search]: Select [Video Title] or [Cast Member], then enter a keyword.

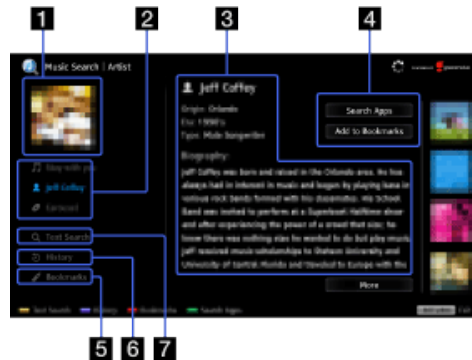

- The [Music Search] screen is used as an example.

### 1 Artwork

Displays image of selected item (e.g. album jacket).

### 2 Content tabs

In case of [Music Search]: Enables access to information about track, artist, and album.

In case of [Video Search]: Enables access to information about video, cast, and content-related links.

### 3 Details

Displays details about the selected tab.

### 4 Search Apps/Add to Bookmarks

[Search Apps]: Enables a search for related content in other applications.

[Add to Bookmarks]: Adds the currently displayed item to Bookmarks for later viewing.

### 5 Bookmarks

In case of [Music Search]: Lists TrackID™ search results and items previously added to Bookmarks.

In case of [Video Search]: Lists results previously added to Bookmarks.

### 6 History

Lists a history of viewed items.

### 7 Text Search

Searches for information via keyword (e.g. track title, artist name, video title).

## Managing Bookmarks

You can delete a Bookmark, or protect it from being automatically deleted when the maximum

number of Bookmarks is exceeded.

To add Bookmarks:

1. Select [Track]/[Artist]/[Album] in the [Music Search] application, or [Video]/[Cast] in the [Video Search] application.
2. Select [Add to Bookmarks].

To delete a single Bookmark:

1. In the [Music Search]/[Video Search] application, select [Bookmarks] → the Bookmark to delete.
2. Press OPTIONS, then select [Delete].

To delete all Bookmarks:

1. In the [Music Search]/[Video Search] application, select [Bookmarks].
2. Press OPTIONS, then select [Delete All].



- Protected Bookmarks will not be deleted.

To protect a Bookmark:

1. In the [Music Search]/[Video Search] application, select [Bookmarks] → the Bookmark to protect.
2. Press OPTIONS, then select [Protect].

To unprotect a Bookmark:

1. In the [Music Search]/[Video Search] application, select [Bookmarks] → the Bookmark to unprotect.
2. Press OPTIONS, then select [Unprotect].

[▲ Return to Top](#)

How to Use i-Manual
"BRAVIA" TV Features
<b>Watching TV</b>
Settings/Home Menu
Using Other Equipment/Internet
Parts Description
Troubleshooting
Bookmarks
Index

[→ i-Manual online map](#)

## 3D Feature

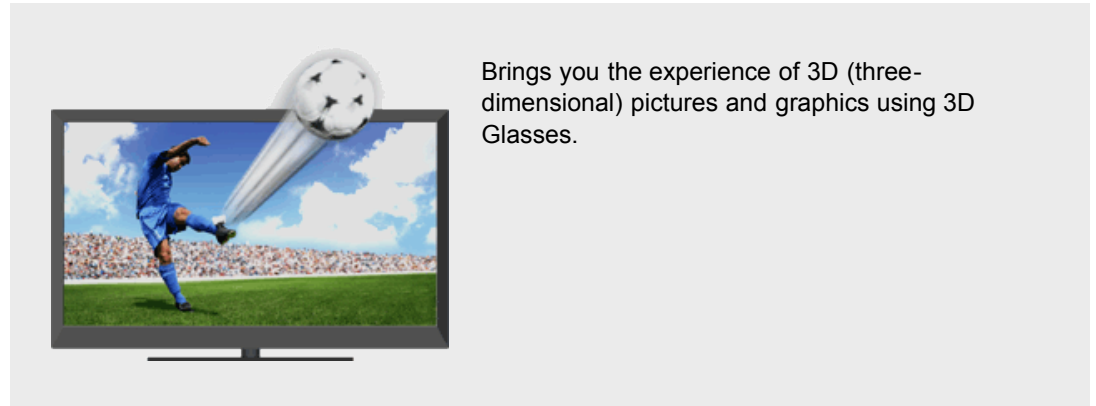

This feature lets you experience powerful 3D entertainment, such as stereoscopic 3D games and 3D Blu-ray Discs.

Turn the 3D Glasses on, then put them on to watch 3D content.

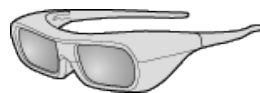

3D Glasses TDG-BR250



- 3D effect is available only when pictures are displayed in full screen.
- Additional viewers with 3D Glasses can also enjoy 3D content.
- The 3D Glasses are supplied or available as an optional accessory, depending on your TV model. In some regions/countries, the 3D Glasses may not be available.
- The 3D Glasses TDG-BR250 may not be available in some regions/countries. If unavailable, use other compatible 3D Glasses.
- If [Motionflow] is set to other than [Off], the smooth movement of the picture may be lost as the picture process to minimize screen flicker is applied. In such a case, set [Motionflow] to [Off] to display the original picture.

## Watching the following pictures in 3D

Regular 2D picture    Side-by-side picture    Over-under picture



1. Press 3D to display the 3D Menu.



2. Press 3D repeatedly to toggle through [3D Display] modes.
  - [Simulated 3D]: Displays regular 2D pictures in simulated 3D.
  - [Side-by-Side]: Displays side-by-side pictures in 3D.
  - [Over-Under]: Displays over-under pictures in 3D.
  - [Off]: Displays pictures as they are.
3. Press RETURN to exit the 3D Menu.



- Simulated 3D effect may be less pronounced with some picture sources.
- Perceived simulated 3D effect may vary from person to person.
- Simulated 3D display mode automatically switches back to 2D display mode an hour after its activation.

## Watching 3D content in 2D

1. Press 3D to display the 3D Menu.



2. Press 3D to select [Off] in [3D Display].
3. Press RETURN to exit the 3D Menu.



- The 3D display mode is automatically selected when a 3D signal is detected.
- To prevent 3D display mode from being automatically selected when a 3D signal is detected, press HOME, then select  → [Picture & Display] → [3D Settings] → [Auto 3D] → [Off].

## 3D Sync Transmitter and 3D Glasses communication range

The recommended viewing angle and distance are shown in the illustrations. To enjoy the best 3D effect, the preferred viewing position needs to be kept within the range where the 3D Sync Transmitter works.

Overhead view

Side view

45°

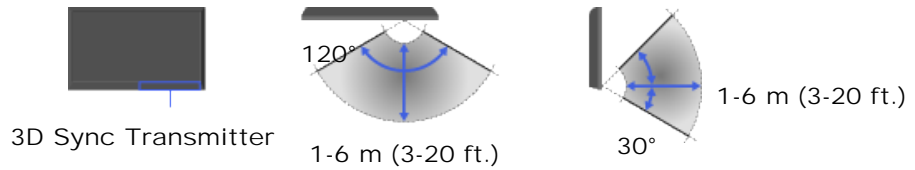

- Recommended viewing angle and distance may vary depending on the TV's location and room conditions.
- Do not put anything in front of the 3D Sync Transmitter. Doing so may affect its function.
- Signals between the 3D Sync Transmitter and 3D Glasses may be interrupted if an infrared device is used near the TV.

## 3D Menu

You can adjust the following settings from the 3D Menu.  
Press 3D, then select the desired setting → the desired option.

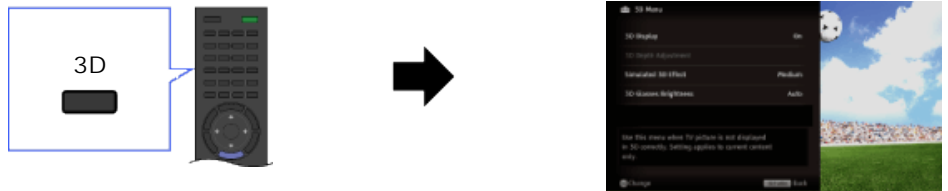

## 3D Display

When 3D pictures are displayed:

Switches between the 3D and 2D display modes.

When non-3D pictures are displayed:

[Simulated 3D]: Displays regular 2D pictures in simulated 3D.

[Side-by-Side]: Displays side-by-side pictures in 3D.



- Two near-identical pictures for 3D viewing are displayed side-by-side.

[Over-Under]: Displays over-under pictures in 3D.



- Two near-identical pictures for 3D viewing are displayed one above the other.



[Off]: Displays pictures as they are.

---

### 3D Depth Adjustment

Adjusts the depth of 3D pictures on the screen.



- Available only for content with 3D signals.
- Selecting [0] is recommended for normal use.
- 3D effect may be less pronounced depending on the settings.

---

### Simulated 3D Effect

Heightens/lessens the 3D effect when you display 2D pictures in simulated 3D.

---

### 3D Glasses Brightness

Sets the image brightness when using 3D display mode.



- By selecting [Auto], image brightness through the 3D Glasses is automatically adjusted in conjunction with the [Picture Mode] setting.

---

[▲ Return to Top](#)

How to Use i-Manual

“BRAVIA” TV Features

Watching TV

Settings/Home Menu

Using Other  
Equipment/Internet

Parts Description

Troubleshooting

Bookmarks

Index

→ i-Manual online map

## Rovi On Screen Guide™

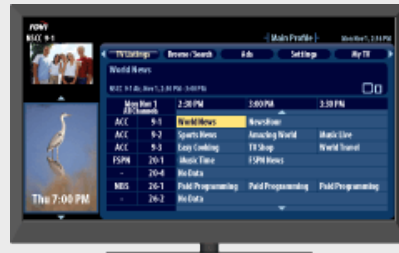

Provides up to 24 hours of program information and easy personalization of program listings.

This feature provides up to 24 hours of program information and easy personalization of program listings. You can search for programs by category or keyword.

Press GUIDE to display the program guide.

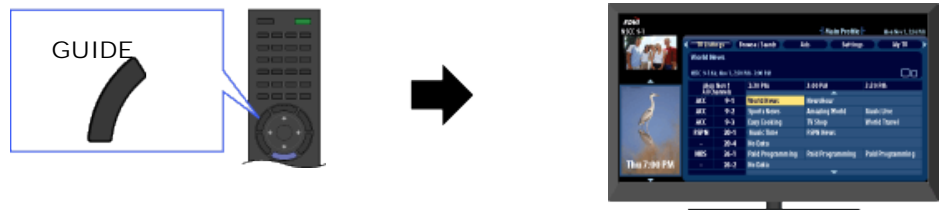

- To change the information source for program information (to Broadcaster or to Guide), press HOME, then select  → [Channels & Inputs] → [Program Information Source] → the desired setting.
- When [Broadcaster] is selected for the source of program information, the TV will not display a program guide, but each individual program will have program information shown onscreen when the channel is tuned.
- Rovi On Screen Guide is available with connection to your cable service or with over-the-air antenna signal.
- You must connect your signal directly to the TV's CABLE or ANTENNA input without using a set-top box.
- Be sure to complete the initial setup to use this feature.
- DAM (Download Acquisition Mode) is used for software updates and/or collecting data for Rovi On Screen Guide. When DAM is activated, power consumption may increase.



**1** Video preview window

Displays the last viewed TV channel before entering the guide. You can also set this to preview the program that is selected within the program listings.

**2** Information box

Shows detailed program information.

**3** Rovi On Screen Guide menu area

Enables selection of the following features.

- [TV Listings]: Shows up to 24 hours of program listings, and organizes the program listings by category.
- [Browse/Search]: Searches for programs by browsing through categories, or by entering a keyword or title.
- [Ads]: Provides advertisements from Rovi On Screen Guide sponsors.
- [Settings]: Adjusts the settings for the Rovi On Screen Guide.
- [My TV]: Organizes the program listings.

**4** Ad panels

Provides advertisements from Rovi On Screen Guide sponsors.

**5** Channel logo

Displays the broadcaster's channel logo.

**6** Listings grid

Enables selection of a program to watch or to obtain program information.

## Organizing the program listings – My TV

You can organize the program listings by profile (e.g. Movie, Sport, Kids), and create your own profile to organize your favorite programs, channels or keywords.

Select [My TV] from the menu area to launch.



- Channels you add to the main profile of [My TV] will automatically appear as your favorite channels in [Favorites/History].

[Return to Top](#)

How to Use i-Manual

“BRAVIA” TV Features

Watching TV

Settings/Home Menu

Using Other  
Equipment/Internet

Parts Description

Troubleshooting

Bookmarks

Index

[→ i-Manual online map](#)

## Favorites



Provides quick access to your frequently used and recently viewed items, such as TV channels, external inputs or your media files.

This feature provides quick access to your frequently used and recently viewed items, such as TV channels or external inputs (e.g. game console, DVD player). You can manage various items including your media files, Internet content and Widgets, and select them from Favorites.

Press HOME, then select  → the desired item.



- A slideshow automatically starts when a folder of photos is selected.
- Internet content (e.g. Internet Video, Widgets) may not be available in some regions/countries.
- Recently viewed items are cleared every time the TV is turned off.

## Managing Favorites

You can add/remove items in Favorites.

1. Display the desired item, or select one in the Home Menu.
2. Press OPTIONS, then select [Add to Favorites] or [Remove from Favorites].

[▲ Return to Top](#)

- How to Use i-Manual
- "BRAVIA" TV Features
- Watching TV
- Settings/Home Menu
- Using Other Equipment/Internet
- Parts Description
- Troubleshooting
- Bookmarks
- Index

[→ i-Manual online map](#)

## Wide Mode

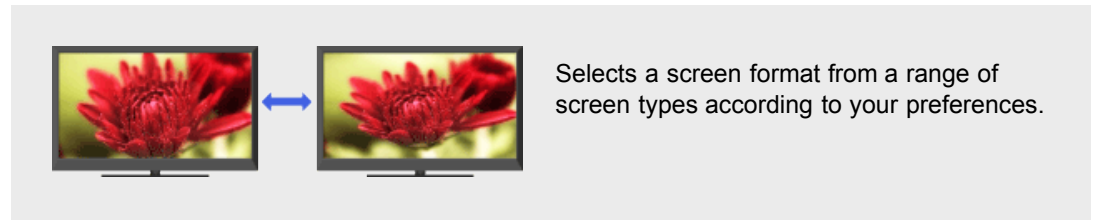

This feature is for you to select a screen format to better fit content you are viewing.

Press WIDE repeatedly to select the desired option, then press .

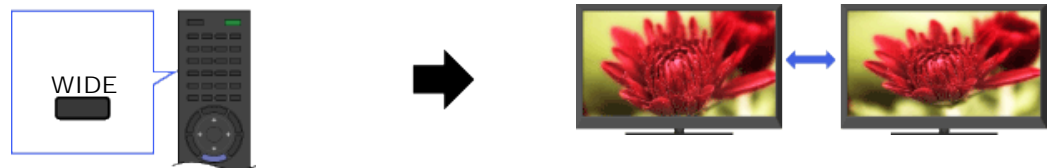

- Based on the original signal source, a black frame or black bars may surround the picture.

## Changing the wide mode from 4:3 original source

### Wide Zoom

Enlarges the picture to fill a 16:9 screen, preserving the original picture as much as possible.

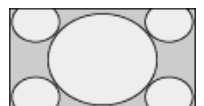

### Normal

Displays a 4:3 picture in its original size. Side bars are shown to fill the 16:9 screen.

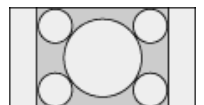

### Full

Stretches the 4:3 picture horizontally, to fill the 16:9 screen.

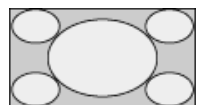

### Zoom

Displays the cinemascopic (letter box format) picture in the correct proportion.



---

### Captions

Stretches the picture horizontally to fill a 16:9 screen, while fitting captions in the screen.

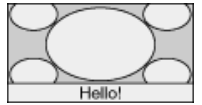

---

### Changing the wide mode from 16:9 original source

#### Wide Zoom

Enlarges the picture to fill a 16:9 screen, preserving the original picture as much as possible.

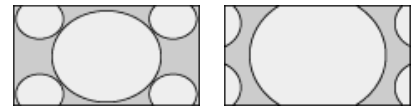

---

#### Normal

Displays a picture in its original size.

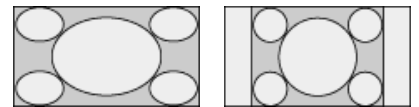

---

#### Full

Displays a 16:9 picture in its original size.

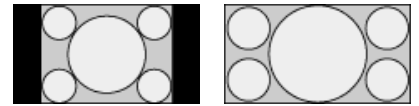

---

#### Zoom

Displays the cinematographic (letter box format) picture in the correct proportion.



---

### Captions

Stretches the picture horizontally to fill a 16:9 screen, while fitting captions in the screen.

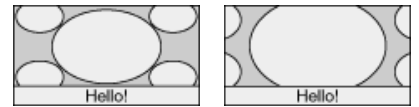

---

### Changing the wide screen mode for PC Timing

800 x 600

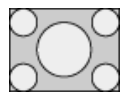

Normal

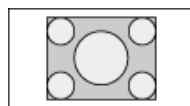

Full 1



Full 2



1,280 x 768



Normal

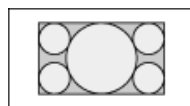

Full 1



Full 2



[▲ Return to Top](#)



How to Use i-Manual

“BRAVIA” TV Features

Watching TV

Settings/Home Menu

Using Other  
Equipment/Internet

Parts Description

Troubleshooting

Bookmarks

Index

[→ i-Manual online map](#)

## Picture Mode



Allows you to select the picture mode according to your preference.

You can select the picture mode according to your preference.

Press HOME, then select  → [Picture & Display] → [Picture Adjustments] → [Picture Mode] → the desired option.

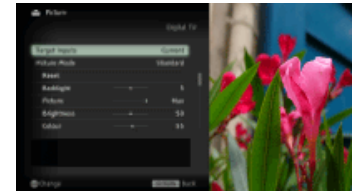
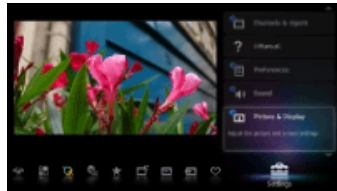

- The option you can select may vary depending on the situation.
- Unavailable options are grayed out or not displayed.

[▲ Return to Top](#)



How to Use i-Manual

"BRAVIA" TV Features

**Watching TV**

Settings/Home Menu

Using Other  
Equipment/Internet

Parts Description

Troubleshooting

Bookmarks

Index

[→ i-Manual online map](#)

## Photos/Music/Videos

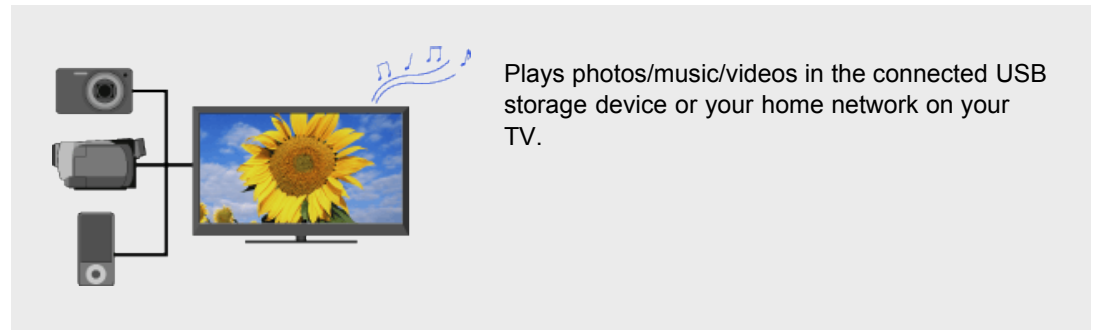

You can play photos/music/videos in the connected USB storage device or your home network on your TV.

1. Connect the USB storage device or connect to your home network.  
For details, see "USB Device (e.g. Digital Camera)" or "Connecting to a Home Network" in this manual.
2. Press HOME, then select → [Photos], [Music] or [Videos] → the desired USB device or media server.
3. Select files or folders to play from the list.



- Photo playback automatically starts when you connect a USB storage device after turning on the TV, and [Slideshow] or [Thumbnail View] is selected in the [USB Auto Start] settings. Photo files must be stored in a folder under the DCIM folder for automatic playback start. Also, the folder name under the DCIM folder is required to be a combination of 3 numerals and 5 letters (can include "\_"), for example, 101MSDCF.
- When connecting a Sony digital camera to the TV with a USB cable, USB connection settings on your camera need to be set to [Auto] or [Mass Storage] mode.
- For details on compatible devices, file formats, etc., see "USB Device (e.g. Digital Camera)" or "Connecting to a Home Network" in this manual.

[▲ Return to Top](#)

How to Use i-Manual

"BRAVIA" TV Features

Watching TV

Settings/Home Menu

Using Other  
Equipment/Internet

Parts Description

Troubleshooting

Bookmarks

Index

[→ i-Manual online map](#)

## Twin Picture (PIP)

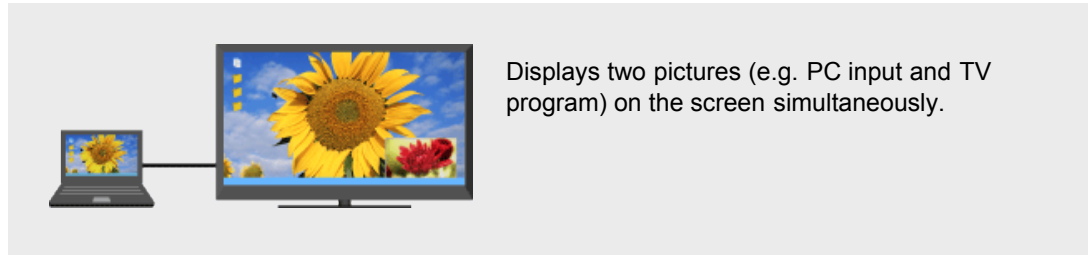

This feature lets you watch two pictures simultaneously. You can have a picture from any input source displayed in full screen, and an input source excluding PC displayed in an inset window.

1. Press **OPTIONS**, then select the option as follows.

For PC input: Select [Twin Picture].

For other than PC input: Select [Twin Picture] → [PIP].

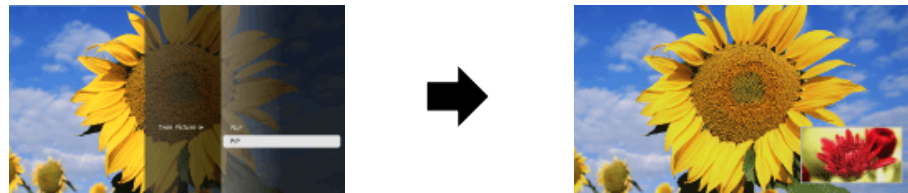

2. Press **←/→** to switch audio output between the two pictures.

## Moving the inset window

Press **↑/↓**.



- Available combination of two pictures varies depending on your region/country.
- Available inputs may vary depending on the TV model.
- If two pictures with different vertical frequency signals (e.g. a picture in full screen with 24p and a picture in an inset window with 60i) are displayed simultaneously, the smooth movement of the picture in an inset window may be lost.
- If [CineMotion] is set to [Auto 1], the smooth movement of the picture in an inset window may be lost. (For [Motionflow] compatible models only.) To remedy this, set to [Auto 2] or [Off]. Press **HOME**, then select **☰** → [Picture & Display] → [Picture Adjustments] → [CineMotion] → [Auto 2]/[Off].

[▲ Return to Top](#)

How to Use i-Manual

"BRAVIA" TV Features

**Watching TV**

Settings/Home Menu

Using Other  
Equipment/Internet

Parts Description

Troubleshooting

Bookmarks

Index

[→ i-Manual online map](#)

## Twin Picture (P&P)

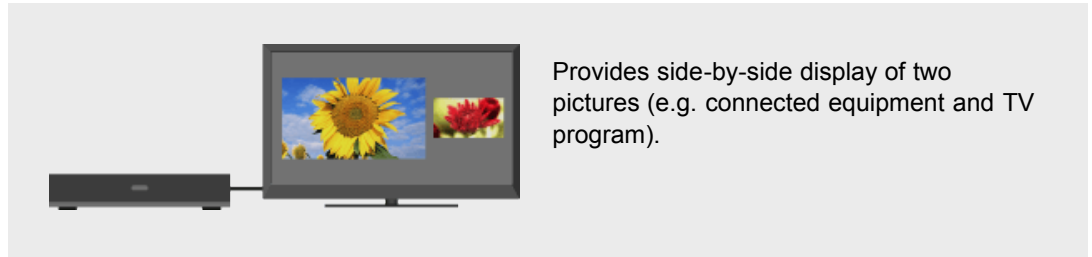

This feature provides side-by-side display of two pictures. You can simultaneously enjoy, for example, a picture from connected equipment and TV program.

1. Press **OPTIONS**, then select **[Twin Picture] → [P&P]**.

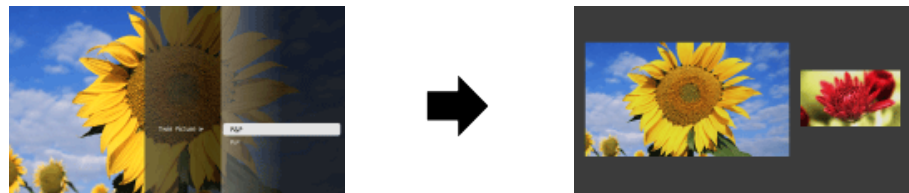

2. Press **←/→** to switch audio output between the two pictures.  
The highlighted picture is audible.

## Changing the picture size

1. Press **←/→** to select the picture.
2. Press **▲/▼** repeatedly to change the size.



- This function is not available with PC input.
- Available combination of two pictures varies depending on your region/country.
- If two pictures with different vertical frequency signals (e.g. a left picture with 24p and a right picture with 60i) are displayed side-by-side, the smooth movement of the right picture may be lost.

[▲ Return to Top](#)

- How to Use i-Manual
- "BRAVIA" TV Features
- Watching TV
- Settings/Home Menu
- Using Other Equipment/Internet
- Parts Description
- Troubleshooting
- Bookmarks
- Index

[→ i-Manual online map](#)

## About the Home Menu

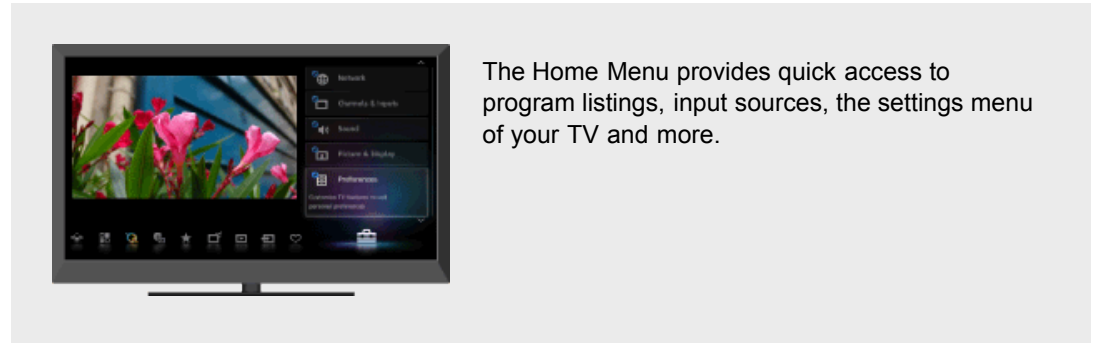

The Home Menu provides quick access to program listings, input sources, the settings menu of your TV and more.

With the Home Menu, you can customize your TV settings. The Home Menu also provides access to various content, such as TV channels, media files, applications, etc.

1. Press HOME to display the Home Menu.

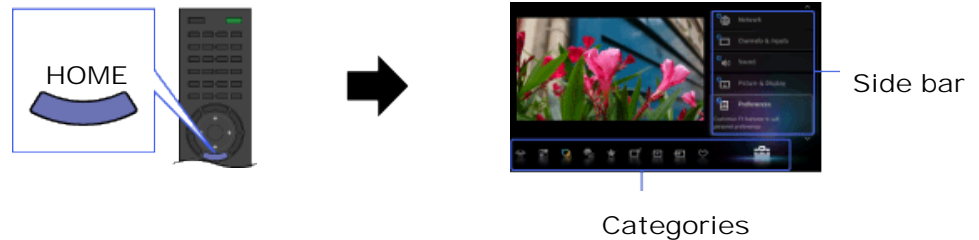

2. Press  $\leftarrow/\rightarrow$  to select a category.
3. Press  $\uparrow/\downarrow$  to select an item in the side bar, then press  $\odot$ .

### Tip on how to configure your TV settings

In the "Settings" section of this manual, you can find instructions on how to access the setting at the left of each description. Use these instructions to help configure your TV settings.

### Categories in the Home Menu

The category icons organize your TV settings and TV features for quick and easy access.



Settings

Provides the settings that allow you to customize your TV.



Widgets

Enables access to Widgets.



- Available Widgets depend on your region/country. If Widgets are unavailable, the [Widgets] category is not displayed.
- MAC address and IP address are transmitted automatically from the

TV to servers while an Internet connection is available. The servers are under the control of Sony, and MAC address will never be transmitted to servers controlled by other parties.



### Applications

Launches applications such as [Music Search], [Internet Browser], etc.



### Qriocity

Enables access to the “Qriocity” online service.



- This service is available depending on your region/country.



### Internet Content

Enables access to Internet services for TV.



### Recommendations

Presents recommendations for programs you may like, based on your viewing history.



- To show/hide [Recommendations], press HOME, then select  → [Preferences] → [Recommendation] → [On]/[Off].
- This function may not be available depending on your region, country and broadcasting conditions.



### TV

Allows you to select a list of TV channels, or a program guide.



- Program guide is available depending on your TV model or region.



### Media

Enables selection of media files (photo, music, video) to play in a connected USB storage device or your home network.



### Inputs

Enables selection of equipment connected to the TV.



### Favorites/History

Displays items in Favorites and recently viewed items.



- The items you can select may vary depending on the situation.
- Unavailable items are grayed out or not displayed.

[▲ Return to Top](#)

How to Use i-Manual

“BRAVIA” TV Features

Watching TV

Settings/Home Menu

Using Other  
Equipment/Internet

Parts Description

Troubleshooting

Bookmarks

Index

[→ i-Manual online map](#)

## Picture & Display

[Picture Adjustments](#)

[3D Settings](#)

[Screen \(for inputs other than a PC\)](#)

[Screen \(for PC input\)](#)

[Pro Picture Setup](#)

[▲ Return to Top](#)

How to Use i-Manual

“BRAVIA” TV Features

Watching TV

Settings/Home Menu

Using Other  
Equipment/Internet

Parts Description

Troubleshooting

Bookmarks

Index

[➔ i-Manual online map](#)

## Sound

[Sound Adjustments](#)

[MTS Audio](#)

[Speakers](#)

[Headphone/Audio Out](#)

[Headphone Speaker Link](#)

[Audio Out](#)

[HDMI/DVI Audio Source](#)

[Key Tone](#)

[Startup Sound](#)

[TV Position](#)

[▲ Return to Top](#)

How to Use i-Manual

“BRAVIA” TV Features

Watching TV

Settings/Home Menu

Using Other  
Equipment/Internet

Parts Description

Troubleshooting

Bookmarks

Index

[→ i-Manual online map](#)

## Preferences

[Scene Select](#)

[Eco](#)

[Clock/Timers](#)

[Language](#)

[Region](#)

[Closed Captions \(CC\)](#)

[Parental Lock](#)

[Info Banner](#)

[Recommendation](#)

[Picture Adjustments Lock](#)

[Initial Setup](#)

[▲ Return to Top](#)



How to Use i-Manual
"BRAVIA" TV Features
Watching TV
<b>Settings/Home Menu</b>
Using Other Equipment/Internet
Parts Description
Troubleshooting
Bookmarks
Index

[→ i-Manual online map](#)

## i-Manual

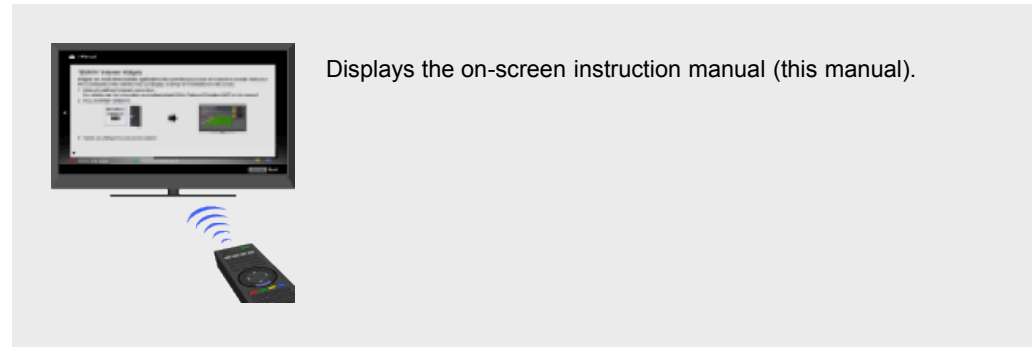

Displays the on-screen instruction manual (this manual).

Displays the on-screen instruction manual (this manual).

Please review the Setup Guide (Operating Instructions) accompanying this television for important information on usage.

### Indicators on the i-Manual screen



### i-Manual operations

To return to the previous layer/proceed to the next layer, press **◀/▶**.

To step through pages, press **▲/▼**.

To jump to the top page of i-Manual, press the corresponding color button.

To bookmark the page/remove bookmark, press the corresponding color button.

To operate the TV or change settings, press i-MANUAL to exit i-Manual.



- Some features can be started directly from the i-Manual. Press **⊕** to start the feature when [Use this feature] is displayed at the bottom of the screen.

[▲ Return to Top](#)

[How to Use i-Manual](#)

["BRAVIA" TV Features](#)

[Watching TV](#)

[Settings/Home Menu](#)

[Using Other  
Equipment/Internet](#)

[Parts Description](#)

[Troubleshooting](#)

[Bookmarks](#)

[Index](#)

[→ i-Manual online map](#)

## Channels & Inputs

[Manage Inputs](#)

[Cable/Antenna](#)

[Auto Program](#)

[Add Digital Channels](#)

[Show/Hide Channels](#)

[Edit Channel Labels](#)

[Program Information Source](#)

[Analog Fine Tune](#)

[Video 2/Component Selection](#)

[HDMI Settings](#)

[USB Auto Start](#)

[▲ Return to Top](#)

How to Use i-Manual

“BRAVIA” TV Features

Watching TV

Settings/Home Menu

Using Other  
Equipment/Internet

Parts Description

Troubleshooting

Bookmarks

Index

[➔ i-Manual online map](#)

## Network

[Network Setup](#)

[Refresh Internet Content](#)

[Home Network Setup](#)

[▲ Return to Top](#)

How to Use i-Manual

“BRAVIA” TV Features

Watching TV

Settings/Home Menu

Using Other  
Equipment/Internet

Parts Description

Troubleshooting

Bookmarks

Index

[➔ i-Manual online map](#)

## Product Support

[Contact Sony](#)

[Signal Diagnostics](#)

[Automatic Software Download](#)

[Software Update](#)

[▲ Return to Top](#)

- How to Use i-Manual
- "BRAVIA" TV Features
- Watching TV
- Settings/Home Menu
- Using Other Equipment/Internet
- Parts Description
- Troubleshooting
- Bookmarks
- Index

[→ i-Manual online map](#)

## VCR/DVD Player

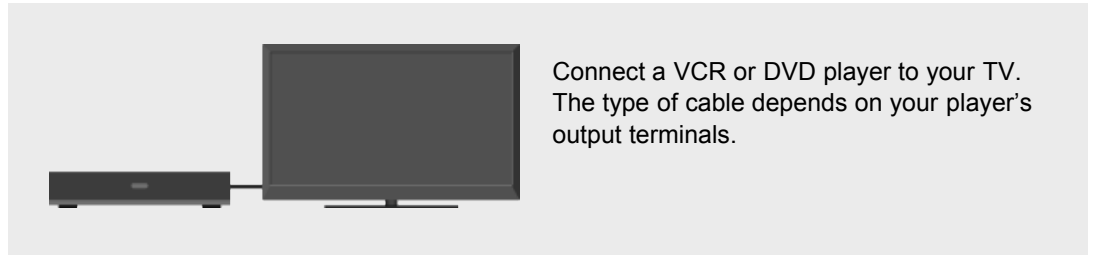

You can connect a VCR or DVD player to your TV. Use a connection cable appropriate for your player's output terminals.

### HDMI connection

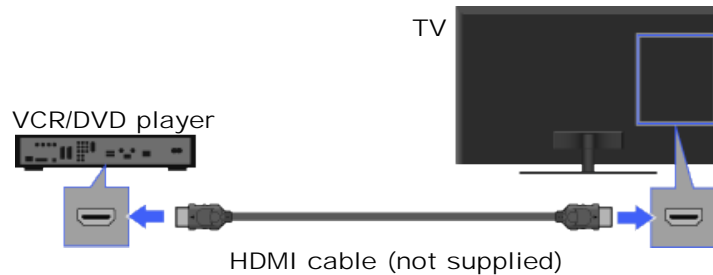

- HDMI connection is recommended for optimum picture quality.

### Component video connection

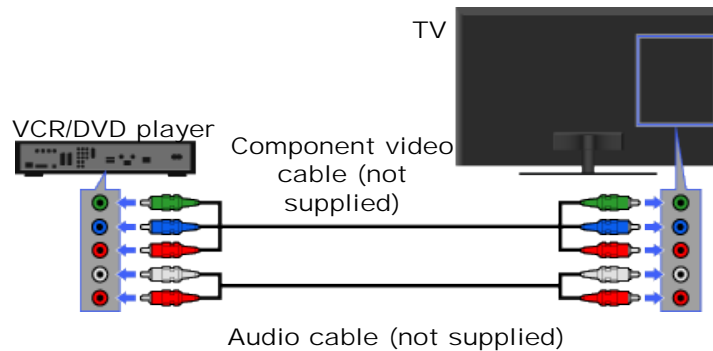

### Composite connection

TV

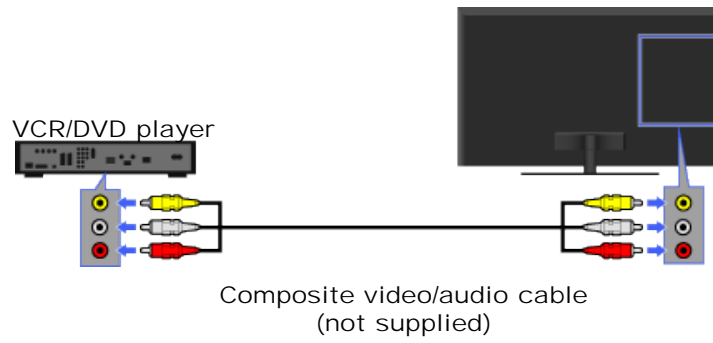

## Viewing pictures from connected equipment

---

1. Turn on the connected equipment.
2. Press INPUT, then select the desired input source.



[▲ Return to Top](#)

How to Use i-Manual
"BRAVIA" TV Features
Watching TV
Settings/Home Menu
<b>Using Other Equipment/Internet</b>
Parts Description
Troubleshooting
Bookmarks
Index

[→ i-Manual online map](#)

## Audio System

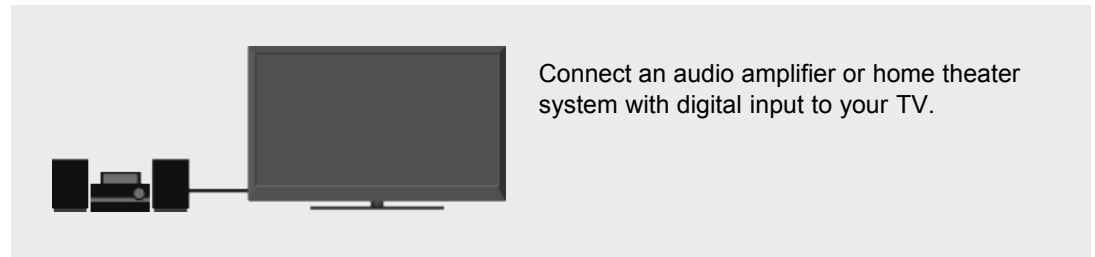

You can connect an audio amplifier or home theater system with digital input to your TV. Use an appropriate connection cable.

### Optical audio connection

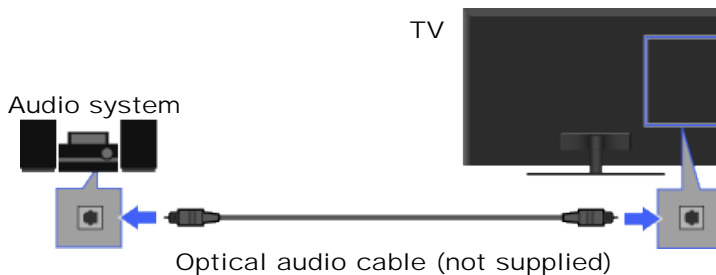

### HDMI connection

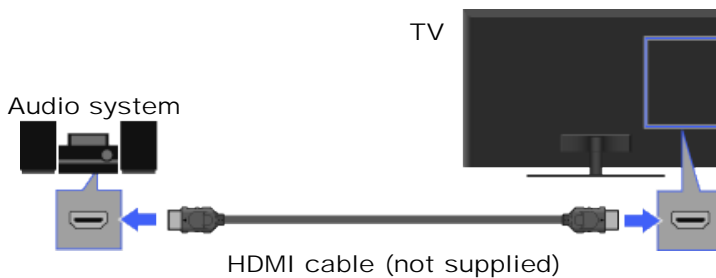

- When connecting a digital audio system that is compatible with "Control for HDMI" ("BRAVIA" Sync) and Audio Return Channel (ARC) technology, connect to HDMI IN 1 with an HDMI cable. If connecting a system that is incompatible with "Control for HDMI" or Audio Return Channel, an additional audio connection via DIGITAL AUDIO OUT (OPTICAL) is necessary.

### Audio cable connection

TV

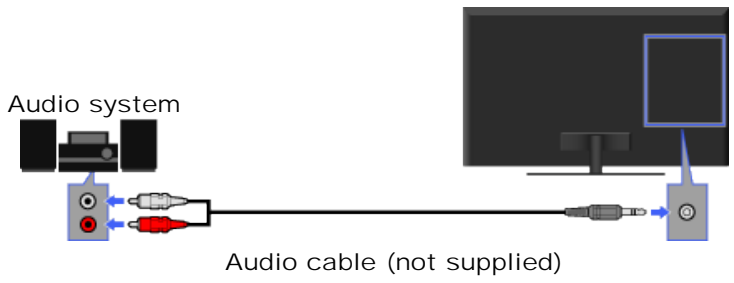

- When using an external audio system, audio out of the TV can be controlled using the TV's remote control.
- To output the sound from the connected audio system, press HOME, then select  → [Sound] → [Headphone/Audio Out] → [Audio Out].

[▲ Return to Top](#)



How to Use i-Manual

"BRAVIA" TV Features

Watching TV

Settings/Home Menu

Using Other  
Equipment/Internet

Parts Description

Troubleshooting

Bookmarks

Index

→ i-Manual online map

## USB Device (e.g. Digital Camera)



You can enjoy photo, music and video files stored in a Sony digital still camera, camcorder or USB storage device by connecting the device via a USB cable.

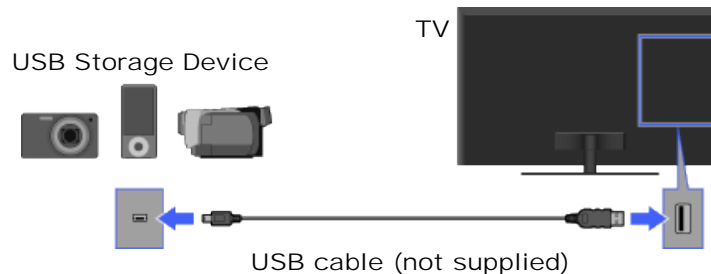

## Playing photos/music/videos

1. Press HOME, then select → [Photos], [Music] or [Videos] → the desired USB device.
2. Select files or folders to play from the list.



- Photo playback automatically starts when you connect a USB storage device after turning on the TV, and [Slideshow] or [Thumbnail View] is selected in the [USB Auto Start] settings. Photo files must be stored in a folder under the DCIM folder for automatic playback start. Also, the folder name under the DCIM folder is required to be a combination of 3 numerals and 5 letters (can include "\_"), for example, 101MSDCF.
- When connecting a Sony digital camera to the TV with a USB cable, USB connection settings on your camera need to be set to [Auto] or [Mass Storage] mode.
- Displaying a 3D Sweep Panorama photo is available only when [Slideshow Effect] is set to [Simple]. (This feature is available on 3D-compatible models only.) To confirm the setting, press OPTIONS, then select [Playback Method] → [Slideshow Effect] → [Simple].
- Scrolling a panoramic photo is available only when [Slideshow Effect] is set to [Simple]/[Crossfade]. To confirm the setting, press OPTIONS, then select [Playback Method] → [Slideshow Effect] → [Simple]/[Crossfade].

## Compatible USB devices/formats

- USB viewer supports FAT12, FAT16, FAT32 and exFAT file systems.
- USB playback of the following photo file formats is available:
  - JPEG (JPEG format files with the extension “.jpg” and conforming to DCF 2.0 or Exif 2.21)
  - RAW (ARW/ARW 2.0 format files with the extension “.arw”) (For preview only.)
  - MPO (files with the extension “.mpo”)
- Only the panoramic JPEG files in the following horizontal/vertical sizes can be scrolled. (If the JPEG file is edited on a PC, etc., scroll may not be possible.)
  - For horizontal scroll: 4912/1080, 7152/1080, 3424/1920, 4912/1920, 12416/1856, 8192/1856, 5536/2160, 3872/2160, 10480/4096
  - For vertical scroll: 1080/4912, 1080/7152, 1920/3424, 1920/4912, 1856/12416, 1856/8192, 2160/5536, 2160/3872, 4096/10480
- USB playback of the following music file formats is available:
  - MP3 (files with the extension “.mp3” that have not been copyrighted)
  - WAV (files with the extension “.wav”)
  - WMA (files with the extension “.wma”)
- USB playback of the following video file formats is available:
  - AVCHD (files with the extension “.mts” or “.m2ts”)
  - MP4 (AVC) (files with the extension “.mp4”)
  - MP4 (MPEG4) (files with the extension “.mp4”)
  - MPEG1 (files with the extension “.mpg”)
  - MPEG2 (files with the extension “.mpg”)
  - WMV (files with the extension “.wmv” or “.asf”)
- Video files are located in the following folder structure (hierarchical position):
  - /AVCHD/BDMV/STREAM/00000.MTS
  - /PRIVATE/AVCHD/BDMV/STREAM/00000.MTS
  - /MP\_ROOT/100ANV01/MAHA0001.MP4



- Avoid losing your files by backing up all your media files stored on a USB device. Sony cannot accept responsibility for lost or damaged data stored on a USB device.
- Depending on the file, playback may not be possible even when using the supported formats.

[▲ Return to Top](#)

How to Use i-Manual

“BRAVIA” TV Features

Watching TV

Settings/Home Menu

Using Other  
Equipment/Internet

Parts Description

Troubleshooting

Bookmarks

Index

[→ i-Manual online map](#)

## Picture Frame



You can set a photo in the connected USB device, network device or preset picture folder to be displayed for a specified time.

You can set a photo in the connected USB device, network device or preset picture folder to be displayed for a specified time.

1. While the desired photo is displayed, press **OPTIONS**, then select **[File Actions]** → **[Picture Frame]**.
2. Press **HOME**, then select  → **[Photos]** → **[Picture Frame]**.



- The TV automatically switches to standby mode after a specified time.

[▲ Return to Top](#)

How to Use i-Manual

“BRAVIA” TV Features

Watching TV

Settings/Home Menu

Using Other  
Equipment/Internet

Parts Description

Troubleshooting

Bookmarks

Index

[➡ i-Manual online map](#)

## HDMI Equipment

[Connecting HDMI Equipment](#)

[Viewing from HDMI Equipment](#)

[“BRAVIA” Sync with “Control for HDMI”](#)

[▲ Return to Top](#)

[How to Use i-Manual](#)

["BRAVIA" TV Features](#)

[Watching TV](#)

[Settings/Home Menu](#)

[Using Other  
Equipment/Internet](#)

[Parts Description](#)

[Troubleshooting](#)

[Bookmarks](#)

[Index](#)

[➔ i-Manual online map](#)

## Internet/Wireless LAN

[Wireless LAN Ready](#)

[Wired LAN](#)

[Browsing Websites](#)

["BRAVIA" Internet Video](#)

[Photomap](#)

[What's New](#)

[▲ Return to Top](#)

How to Use i-Manual

“BRAVIA” TV Features

Watching TV

Settings/Home Menu

Using Other  
Equipment/Internet

Parts Description

Troubleshooting

Bookmarks

Index

[➡ i-Manual online map](#)

## Home Network

[Connecting to a Home Network](#)

[Renderer](#)

[Display Settings for Media Servers](#)

[Media Server Troubleshooting](#)

[▲ Return to Top](#)

How to Use i-Manual

“BRAVIA” TV Features

Watching TV

Settings/Home Menu

Using Other  
Equipment/Internet

Parts Description

Troubleshooting

Bookmarks

Index

[→ i-Manual online map](#)

## Media Remote

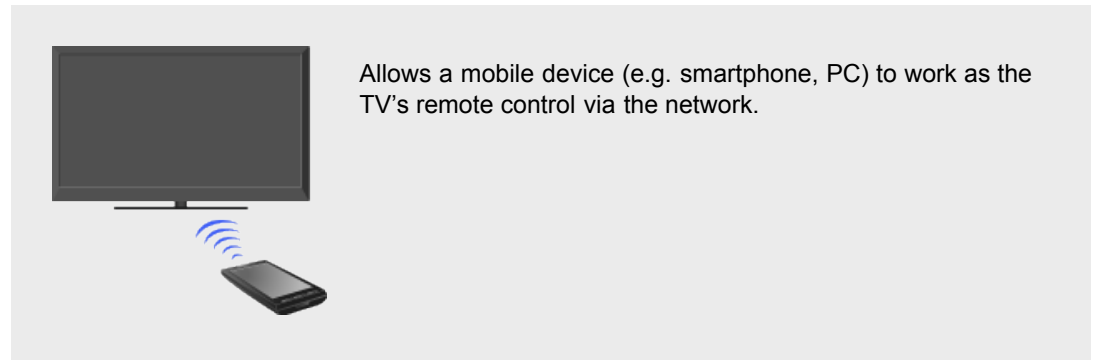

This feature allows a mobile device (e.g. smartphone, PC) to work as the TV's remote control via the network. In addition to the basic remote control functionality, you can enter text using the mobile device when the TV's software keyboard is displayed.

In case of a smartphone, you can use your smartphone to browse “BRAVIA” Internet Video content to play on the TV, or start the TrackID™ search by shaking your smartphone (availability of this function depends on the setting of your smartphone).

The following is required to use this feature.

- In case of a smartphone: Android OS-equipped phone or iPhone on which the “Media Remote” application downloaded and installed.
- In case of a PC: “Remote Keyboard” application installed PC.

### Performing the mutual registration (required only for the first time)

1. Connect the TV and mobile device to the same home network.
2. Launch the “Media Remote”/“Remote Keyboard” application on the mobile device, then search for the TV in the home network.  
The detected device list appears on the mobile device.
3. Select the TV in the detected device list, then perform the required operation on the TV.



- To use this feature, [Remote Device / Renderer] needs to be set to [On]. To confirm the setting, press HOME, then select → [Network] → [Home Network Setup] → [Remote Device / Renderer] → [Remote Device / Renderer] → [On].
- The information about the “Media Remote” and “Remote Keyboard” applications is as of March 2011. The names and available functions of these applications are subject to change.

[▲ Return to Top](#)

How to Use i-Manual
"BRAVIA" TV Features
Watching TV
Settings/Home Menu
Using Other Equipment/Internet
Parts Description
Troubleshooting
Bookmarks
Index

[→ i-Manual online map](#)

## PC

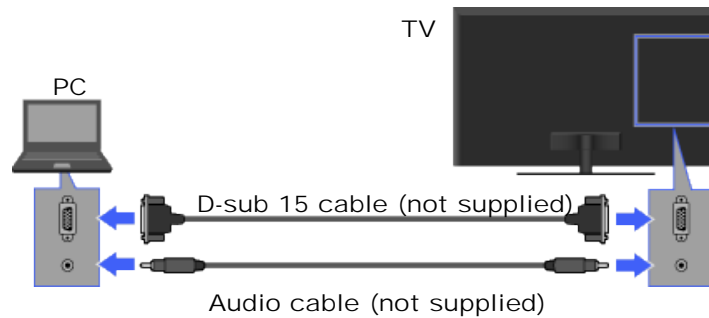
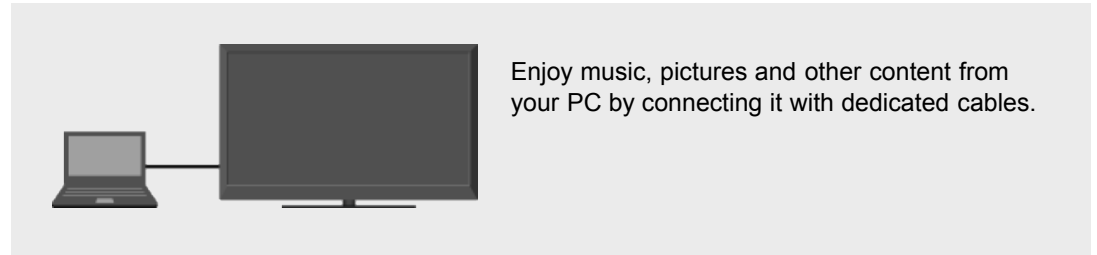

- For some Apple Macintosh computers, it may be necessary to use an adapter (not supplied). If an adapter is used, connect the adapter to the computer before connecting the HD15-HD15 cable.
- You can connect an HDMI-compatible PC with an HDMI cable.

## PC input signal reference chart

- VGA
  - Horizontal (Pixel)/Vertical (Line): 640/480
  - Horizontal frequency (kHz)/Vertical frequency (Hz): 31.5/60
  - Standard: VGA
- SVGA
  - Horizontal (Pixel)/Vertical (Line): 800/600
  - Horizontal frequency (kHz)/Vertical frequency (Hz): 37.9/60
  - Standard: VESA Guidelines
- XGA
  - Horizontal (Pixel)/Vertical (Line): 1024/768
  - Horizontal frequency (kHz)/Vertical frequency (Hz): 48.4/60
  - Standard: VESA Guidelines
- WXGA
  - Horizontal (Pixel)/Vertical (Line): 1280/768, 1280/768, 1360/768
  - Horizontal frequency (kHz)/Vertical frequency (Hz): 47.4/60, 47.8/60, 47.7/60



- Standard: VESA
- SXGA (Full HD model only)
  - Horizontal (Pixel)/Vertical (Line): 1280/1024
  - Horizontal frequency (kHz)/Vertical frequency (Hz): 64.0/60
  - Standard: VESA
- HDTV\* (Full HD model only)
  - Horizontal (Pixel)/Vertical (Line): 1920/1080
  - Horizontal frequency (kHz)/Vertical frequency (Hz): 67.5/60
  - Standard: CEA-861\*



- This TV's PC input does not support Sync on Green or Composite Sync.
- This TV's PC VGA input does not support interlaced signals.
- For optimum picture quality, it is recommended to use the signals in the chart. In plug and play, signals with a 60 Hz vertical frequency will be detected automatically. (PC reboot may be necessary.)

\* The 1080p timing when applied to the HDMI input will be treated as a video timing and not a PC timing. This will affect the [Preferences] and [Picture & Display] settings. To view PC content, set [Scene Select] to [Graphics], [Wide Mode] to [Full], and [Display Area] to [Full Pixel]. ([Display Area] is configurable only when [Auto Display Area] is set to [Off].)

[▲ Return to Top](#)

How to Use i-Manual

"BRAVIA" TV Features

Watching TV

Settings/Home Menu

Using Other  
Equipment/Internet

Parts Description

Troubleshooting

Bookmarks

Index

→ i-Manual online map

## Top

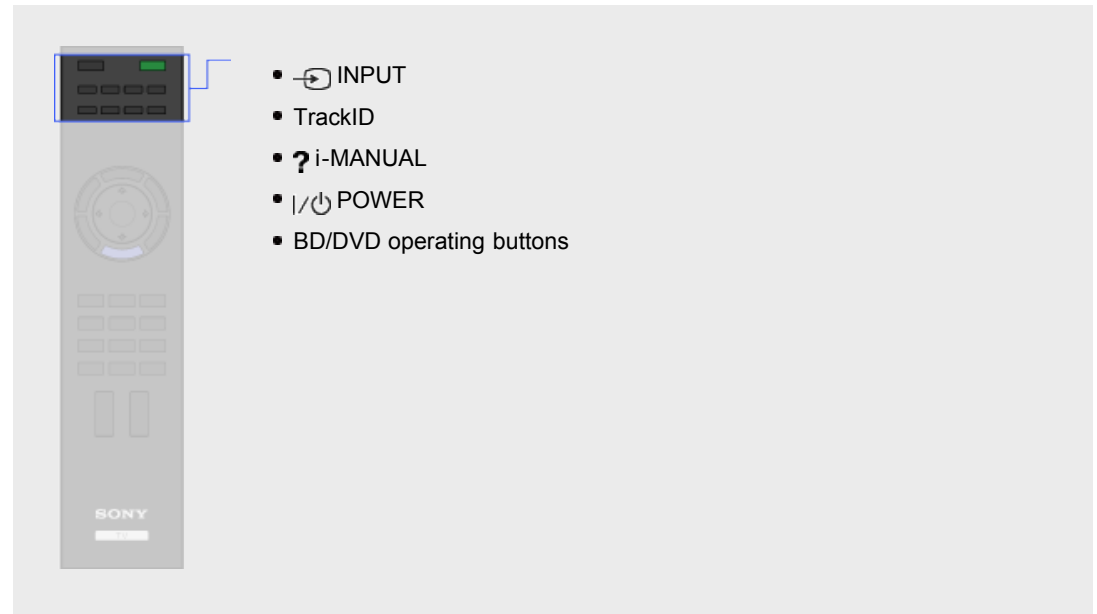

**1** INPUT

Press to display a list of inputs.

**2** TrackID

Searches for information about the music currently playing.

**3** ? i-MANUAL

Press to display the on-screen instruction manual (this manual).

**4** |/⏻ POWER

Press to turn on the TV or to enter standby mode.

**5** BD/DVD operating buttons

⏮⏪⏩⏭: Go to the beginning of the previous/next title/chapter/scene/track.

⏮⏭⏩⏭: Fast reverse/fast forward the disc when pressed during playback.

⏸: Pause or re-start playback.

- ▶ : Play a disc at normal speed.
- : Stop playback.

[▲ Return to Top](#)

---

Copyright 2011 Sony Corporation

How to Use i-Manual
"BRAVIA" TV Features
Watching TV
Settings/Home Menu
Using Other Equipment/Internet
<b>Parts Description</b>
Troubleshooting
Bookmarks
Index

[→ i-Manual online map](#)

## Upper

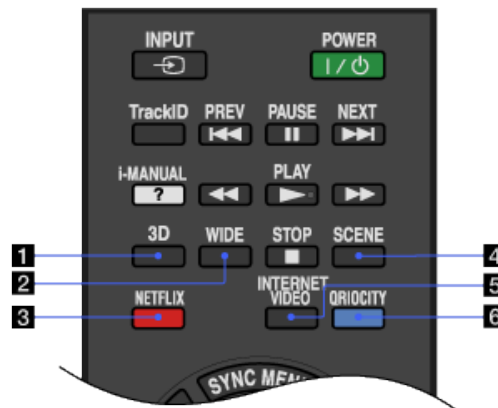
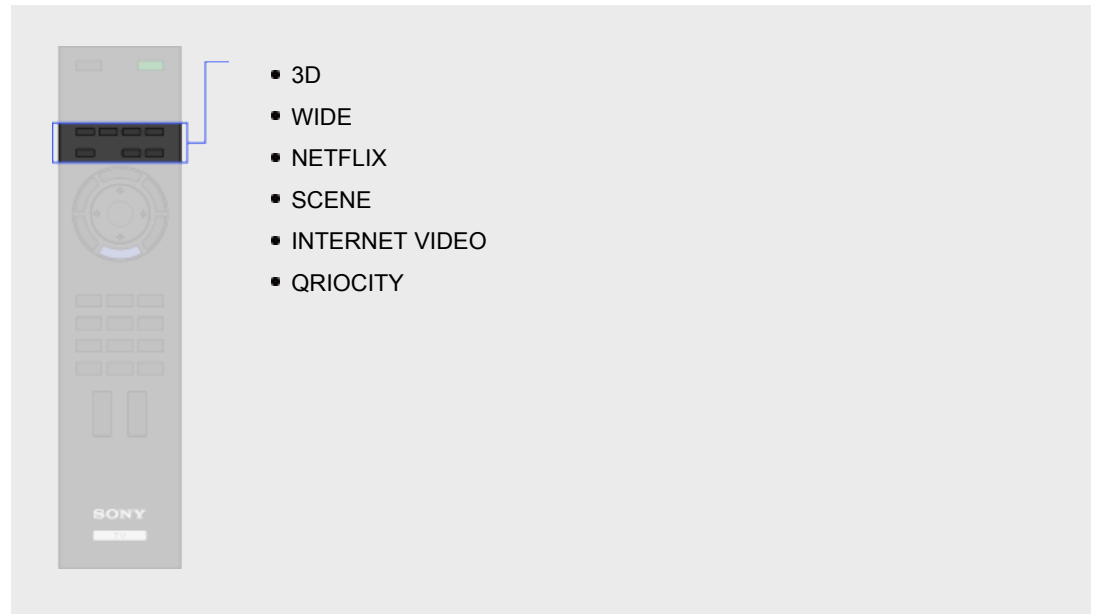

### **1** 3D

Press to display the 3D Menu.

### **2** WIDE

Press to change the wide mode.

### **3** NETFLIX

Press to access the "NETFLIX" online service.



- This feature (button) may not be available in some regions/countries. Details can be referred in Sony website.

### **4** SCENE

Press to display the [Scene Select] menu. Select the desired scene option for optimum sound and picture quality.

**5** INTERNET VIDEO

Press to access Internet content on the Home Menu.

**6** QRIOCITY

Press to access the “Qriocity” online service.

[▲ Return to Top](#)

How to Use i-Manual
"BRAVIA" TV Features
Watching TV
Settings/Home Menu
Using Other Equipment/Internet
<b>Parts Description</b>
Troubleshooting
Bookmarks
Index

[→ i-Manual online map](#)

## Middle

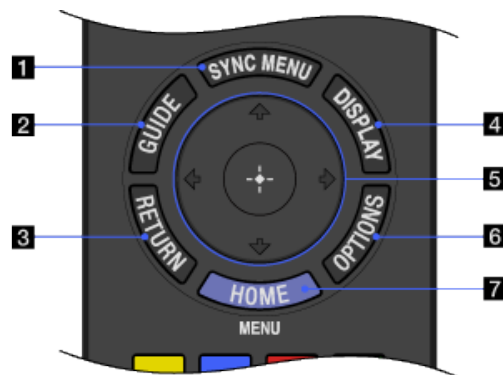
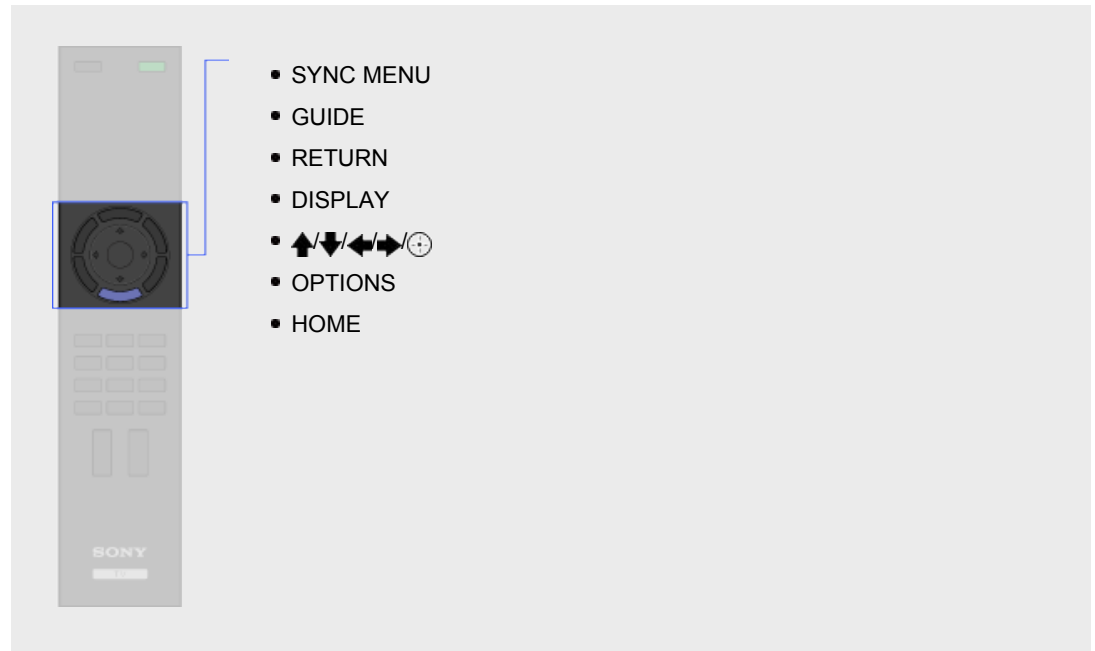

### 1 SYNC MENU

Press to display the "BRAVIA" Sync Menu and then select connected HDMI equipment from [HDMI Device Selection].



- [Control for HDMI] ("BRAVIA" Sync) is only available for connected Sony equipment that has the "BRAVIA" Sync logo or is compatible with "Control for HDMI."

### 2 GUIDE

Press to display the program guide.



- The Guide feature is available depending on your region/country.



### **3** RETURN

Press to return to the previous screen or exit from the menu.

### **4** DISPLAY

Press once to display information about the channel/program/input you are viewing. The information will time out in a few seconds or press again to exit.

### **5**

Press  to move the on-screen cursor. Press  to select/confirm a highlighted item.

### **6** OPTIONS

Press to display a list of convenient functions and menu shortcuts. The menu items vary based on the current input and/or content.

### **7** HOME

Press to display the TV Home Menu.

[▲ Return to Top](#)

How to Use i-Manual
"BRAVIA" TV Features
Watching TV
Settings/Home Menu
Using Other Equipment/Internet
<b>Parts Description</b>
Troubleshooting
Bookmarks
Index

[→ i-Manual online map](#)

## Lower

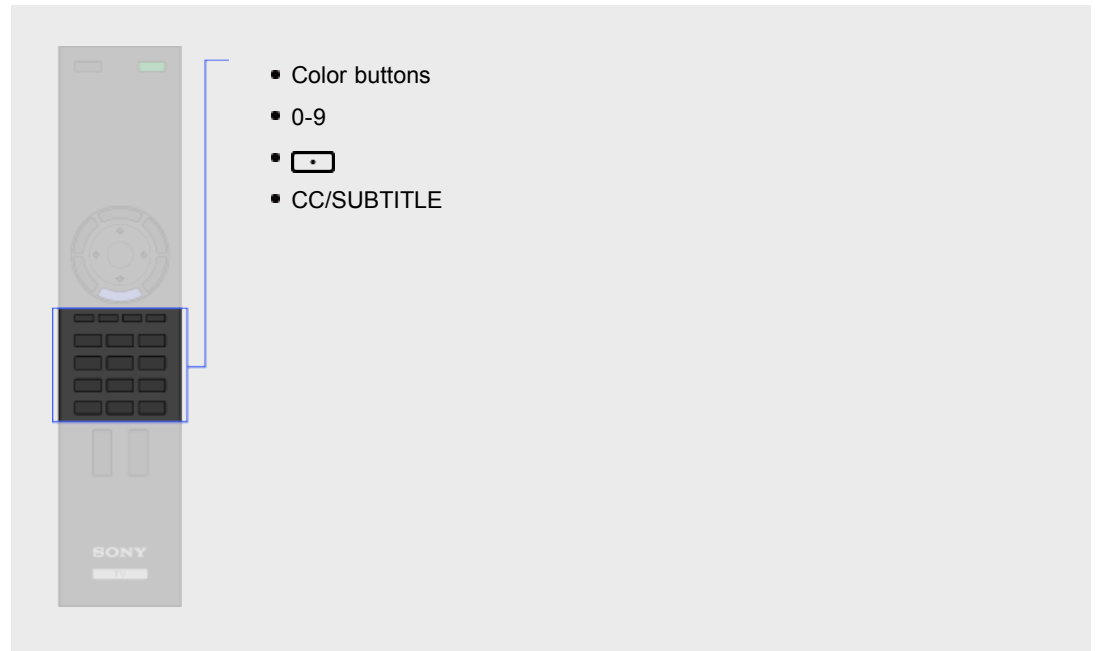

- 1** Color buttons  
When the color buttons are available, an operation guide appears on the screen.
- 2** 0-9  
Press 0-9 to select a channel.
- 3**   
Use with 0-9 to select digital channels. For example, to enter 2.1, press 2, , 1.
- 4** CC/SUBTITLE  
Press to turn closed captions/subtitles on or off (when the feature is available).

[▲ Return to Top](#)





How to Use i-Manual

“BRAVIA” TV Features

Watching TV

Settings/Home Menu

Using Other  
Equipment/Internet

Parts Description

Troubleshooting

Bookmarks

Index

[→ i-Manual online map](#)

## Bottom

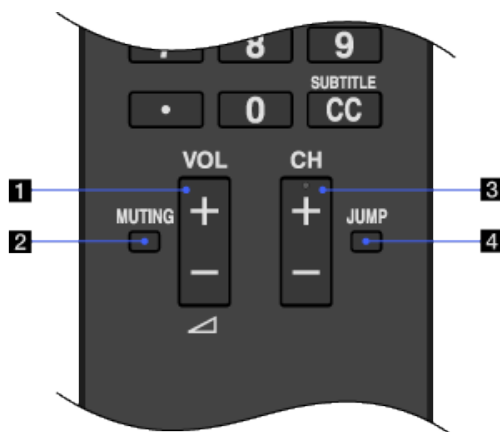

- 1** VOL +/-  
Press to adjust the volume.
- 2** MUTING  
Press to mute the sound. Press again to restore the sound.
- 3** CH +/-  
Press to select the next (+) or previous (-) channel.
- 4** JUMP  
Press to jump back and forth between two channels or inputs. The TV alternates between the current channel or input and the last channel or input that was selected.



How to Use i-Manual
"BRAVIA" TV Features
Watching TV
Settings/Home Menu
Using Other Equipment/Internet
<b>Parts Description</b>
Troubleshooting
Bookmarks
Index

[→ i-Manual online map](#)

## Rear

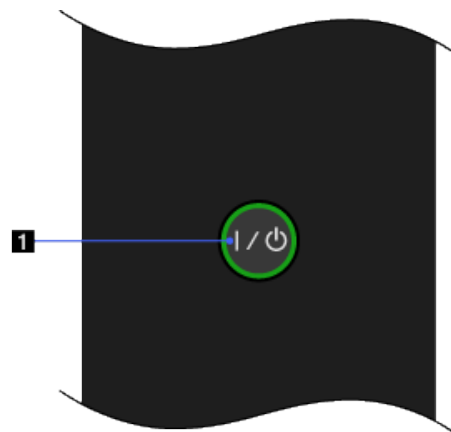
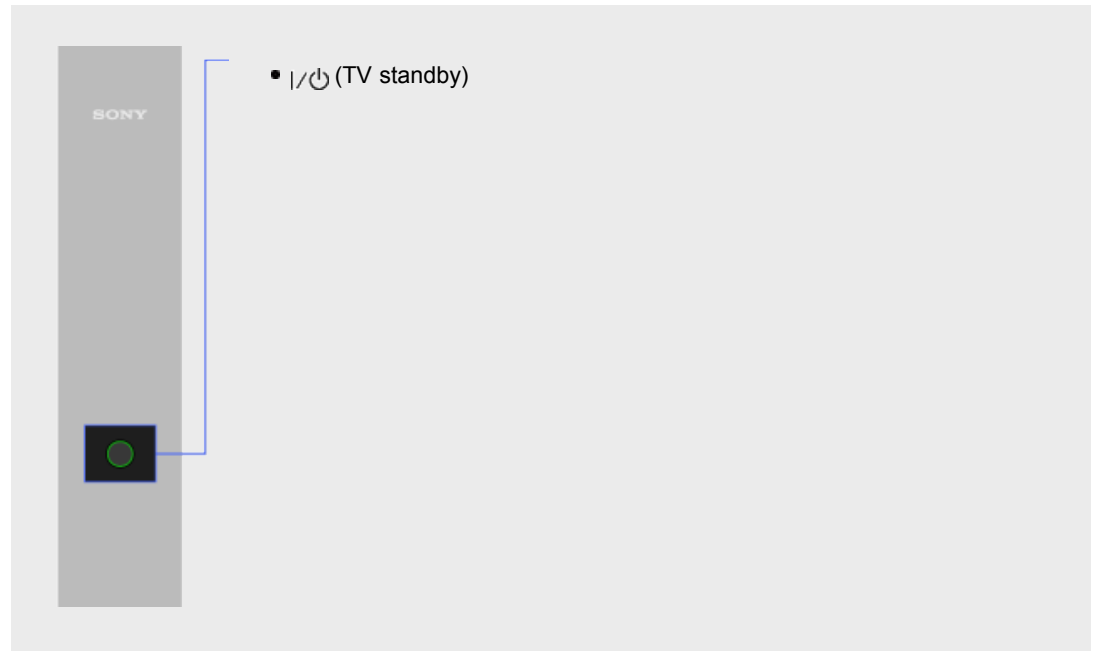

- 1** I/O (TV standby)  
Press to turn on the TV or to enter standby mode.

[▲ Return to Top](#)

How to Use i-Manual

"BRAVIA" TV Features

Watching TV

Settings/Home Menu

Using Other  
Equipment/Internet

Parts Description

Troubleshooting

Bookmarks

Index

→ i-Manual online map

## Front

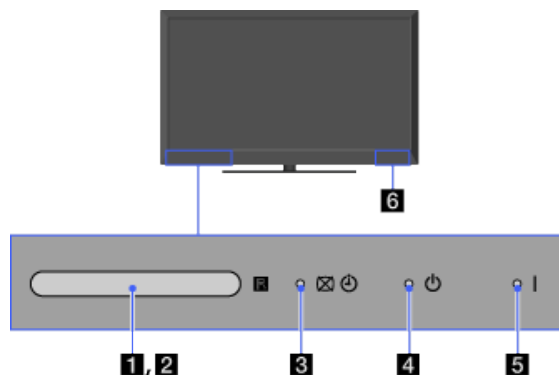
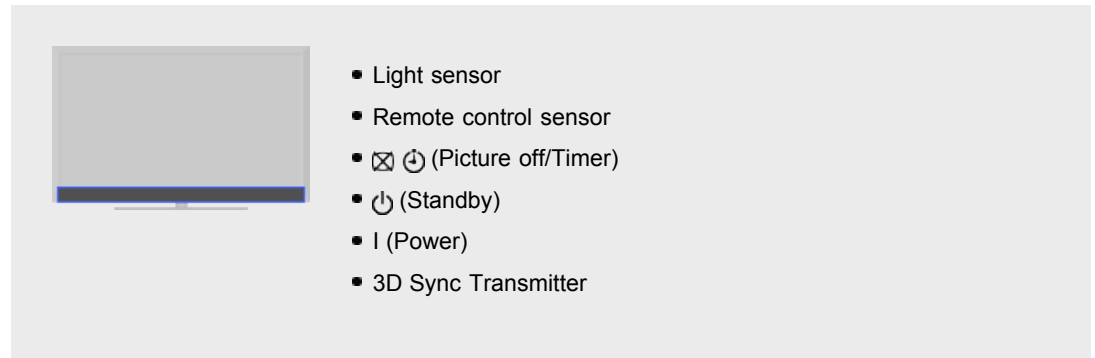

### 1 Light sensor

Senses room light level and adjusts the screen brightness accordingly.  
Do not put anything near the sensor. Doing so may affect its function.

### 2 Remote control sensor

Receives signals from the remote control.  
Do not put anything near the sensor. Doing so may affect its function.

### 3 Picture off/Timer sensor

Lights up in green when you select [Picture Off].  
Lights up in orange when you set the timer.  
Lights up in and/or blinks orange during a software upgrade.

### 4 Standby sensor

Lights up in red when your TV is in standby mode, PC power saving mode or during a software upgrade.

### 5 Power sensor

Lights up in green when the TV is on.

### 6 3D Sync Transmitter

Emits the 3D sync signal.



- Do not put anything in front of the 3D Sync Transmitter. Doing so may affect its function.



How to Use i-Manual

"BRAVIA" TV Features

Watching TV

Settings/Home Menu

Using Other  
Equipment/Internet

Parts Description

Troubleshooting

Bookmarks

Index

→ i-Manual online map

## Right

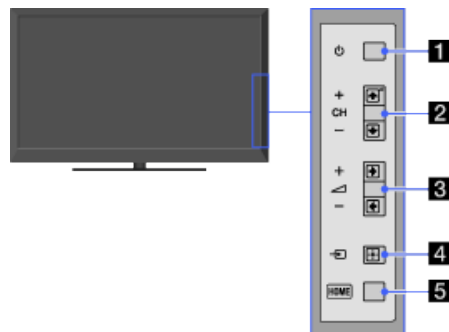
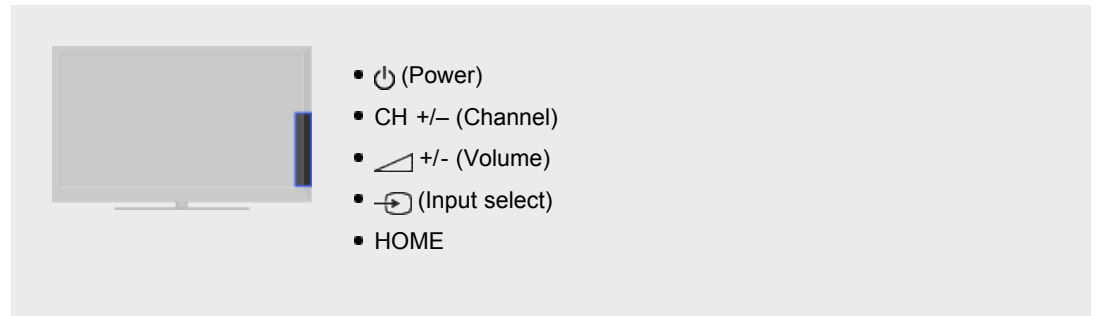

### 1 (Power)

Press to turn on the TV or to enter standby mode.

### 2 CH +/- (Channel)

Press to select the next (+) or previous (-) channel.



- In the TV menu, these buttons will work as .

### 3 +/- (Volume)

Press to adjust the volume.



- In the TV menu, these buttons will work as .

### 4 (Input select)

Press to display a list of inputs.



- In the TV menu, this button will work as .

### 5 HOME

Press to display the TV Home Menu.







How to Use i-Manual

“BRAVIA” TV Features

Watching TV

Settings/Home Menu

Using Other  
Equipment/Internet

Parts Description

Troubleshooting

Bookmarks

Index

→ i-Manual online map

## Rear



- LAN
- DIGITAL AUDIO OUT (OPTICAL)
- CABLE/ANTENNA
- VIDEO IN 1
- VIDEO IN 2, COMPONENT IN
- HDMI IN 1/3/4

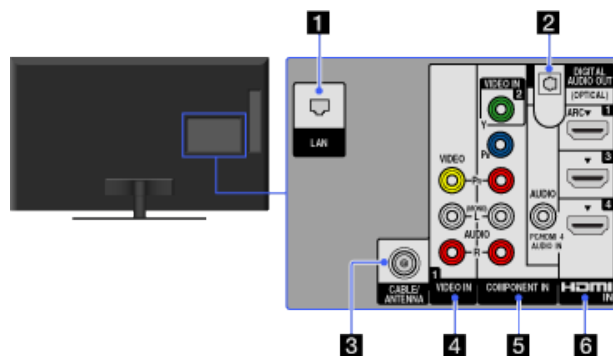

### 1 LAN

Connects to an existing network using an Ethernet cable.

### 2 DIGITAL AUDIO OUT (OPTICAL)

Connects to the optical audio input of digital audio equipment that is PCM/Dolby Digital compatible.

### 3 CABLE/ANTENNA

RF input that connects to your cable or over-the-air antenna.

### 4 VIDEO IN 1

Connect with a composite video cable. When connecting mono equipment, connect to the L (MONO) audio jack.

### 5 VIDEO IN 2, COMPONENT IN

This input can be used as composite video input or as component video input. When connecting mono equipment, connect to the L (MONO) audio jack.

For composite use, connect to VIDEO IN 2 for video, and to AUDIO (L/R) of COMPONENT IN for audio signals.

For component connection, use Y, PB, PR for video signals and also connect to AUDIO (L/R) for audio signals.



- The TV will automatically detect and switch between VIDEO IN 2 and COMPONENT IN. To manually set the input type, press HOME, select  → [Channels & Inputs] → [Video 2/Component Selection].

## 6 HDMI IN 1/3/4

HDMI (High-Definition Multimedia Interface) provides an uncompressed, all-digital audio/video interface between this TV and any HDMI-equipped audio/video equipment. In addition, when you connect equipment that is compatible with "Control for HDMI," communication with the connected equipment is supported.



- Be sure to use only an authorized HDMI cable bearing the HDMI logo.
- If connecting a digital audio system that is compatible with Audio Return Channel (ARC) technology, use HDMI IN 1. If not, an additional connection with DIGITAL AUDIO OUT (OPTICAL) is necessary.
- If the equipment has a DVI jack, connect it to HDMI IN 4 through a DVI - HDMI adapter interface (not supplied), and connect the equipment's audio out jacks to PC/HDMI 4 AUDIO IN.

[▲ Return to Top](#)

How to Use i-Manual
"BRAVIA" TV Features
Watching TV
Settings/Home Menu
Using Other Equipment/Internet
<b>Parts Description</b>
Troubleshooting
Bookmarks
Index

[→ i-Manual online map](#)

## Right

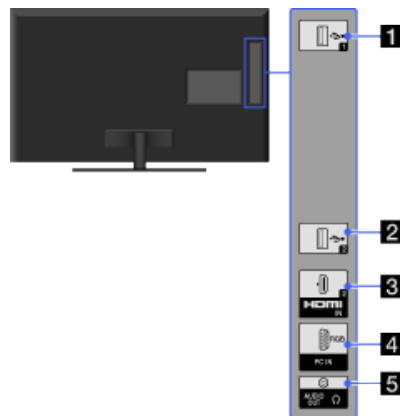
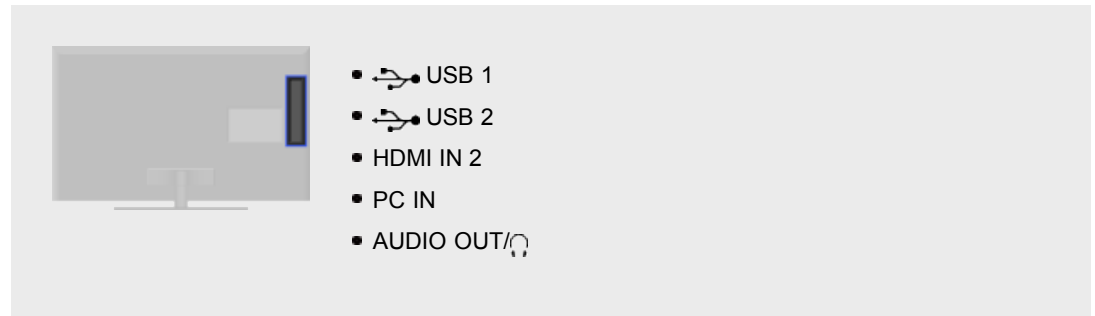

### 1 USB 1

You can enjoy photo, music and video files stored on a USB device.

### 2 USB 2

You can enjoy photo, music and video files stored on a USB device.

### 3 HDMI IN 2

HDMI (High-Definition Multimedia Interface) provides an uncompressed, all-digital audio/video interface between this TV and any HDMI-equipped audio/video equipment. In addition, when you connect equipment that is compatible with "Control for HDMI," communication with the connected equipment is supported.



- Be sure to use only an authorized HDMI cable bearing the HDMI logo.
- If connecting a digital audio system that is compatible with Audio Return Channel (ARC) technology, use HDMI IN 1 on the rear of the TV. If not, an additional connection with DIGITAL AUDIO OUT (OPTICAL) is necessary.
- If the equipment has a DVI jack, connect it to HDMI IN 4 through a DVI - HDMI adapter interface (not supplied), and connect the equipment's audio out jacks to PC/HDMI 4 AUDIO IN on the rear of the TV.

### 4 PC IN

Connects to a personal computer's video and audio output connector. Can also

be connected to other analog RGB equipment.



- For some Apple Macintosh computers, it may be necessary to use an adapter (not supplied). If this is the case, connect the adapter to the computer before connecting the HD15-HD15 cable.
- It is recommended to use a PC cable with ferrite cores.
- To input PC sound, connect to the AUDIO IN jack on the rear of the TV using an audio cable.

## 5 AUDIO OUT

Connect with an audio cable or headphones. You can listen to TV sound through your stereo system or headphones.

To set the sound output for headphones or an external audio system, press HOME, select  → [Sound] → [Headphone/Audio Out].



- When you set [Audio Out] in [Headphone/Audio Out], select [Fixed] or [Variable], press HOME, select  → [Sound] → [Audio Out].

[▲ Return to Top](#)

How to Use i-Manual

“BRAVIA” TV Features

Watching TV

Settings/Home Menu

Using Other  
Equipment/Internet

Parts Description

Troubleshooting

Bookmarks

Index

[→ i-Manual online map](#)

## Picture Symptoms: General

- Picture quality is not as good as viewed at the store.
- Dotted lines or stripes appear.
- No color./Dark picture./Color is not correct./Picture is too bright.
- The screen alternates between dark and bright.
- Blurry picture or poor color.
- Wide Mode changes automatically.
- Suddenly the picture becomes small.
- Black box on screen.
- Black bands appear at the edges of the screen.
- Certain programs on DVD or other digital sources display a loss of detail, especially during fast-motion or dark scenes.

Picture quality is not as good as viewed at the store.

- Picture quality depends on the signal content. See the specifications to display the best possible picture for that signal.

Dotted lines or stripes appear.

- Keep the TV away from noise sources such as cars, motorcycles, or hair-dryers.
- If using the 300-ohm twin lead, move the excess lead away from the TV or try using the 75-ohm coaxial cable (not supplied) instead.

No color./Dark picture./Color is not correct./Picture is too bright.

- Press **OPTIONS**, then select [Picture Adjustments] to make adjustments.
- Adjust [Picture Mode] in [Picture Adjustments].
- If you set [Power Saving] to [Low] or [High], black level will be enhanced.
- If [Presence Sensor] is set to [Moderate], the screen darkens temporarily when the sensor does not recognize any facial patterns, or the picture turns off after no movement is detected for a preset time. (For Intelligent Presence Sensor-compatible models only.)

The screen alternates between dark and bright.

- If [Presence Sensor] is set to [Moderate], the screen darkens temporarily when the sensor does not recognize any facial patterns, or the picture turns off after no movement is detected for a preset time. (For Intelligent Presence Sensor-compatible models only.)

Blurry picture or poor color.

- Transporting the TV from a cold to a warm location or a sudden change in room temperature may cause moisture condensation, resulting in a blurry picture or poor color. Turn off your TV

and wait a few hours before powering on again.

---

Wide Mode changes automatically.

- When changing the channel or video input, if [4:3 Default] in [Screen] is not set to [Off], the current [Wide Mode] setting is automatically replaced with the [4:3 Default] setting. To lock in [Wide Mode] selected with WIDE on the remote control, set [4:3 Default] to [Off].
  - Check the [Auto Wide] setting in [Screen].
- 

Suddenly the picture becomes small.

- The picture becomes smaller during commercials due to the method used by a provider to broadcast content. When HD content channels switch to SD content (commercials), the picture may be small with a black border.
  - [Auto Wide] will not expand the picture while the content switches, since the content information is regulated by the channel signal provider. You can manually change the [Wide Mode] setting if desired, which will remain in effect until you change the channel/input or manually change the [Wide Mode] setting again.
- 

Black box on screen.

- A text option is selected although no text is available. To deactivate this feature, set [CC Display] to [Off]. If you are trying to select closed captioning, select [CC1] instead of [Text1] - [Text4] (options may not be available depending on your region/country).
- 

Black bands appear at the edges of the screen.

- Some wide screen programs are filmed in aspect ratios that are greater than 16:9 (this is especially common with theatrical releases). Your TV will show these programs with black bands at the top and bottom of the screen. For more details, check the documentation that came with your DVD (or contact your program provider).
  - Programs in 4:3 aspect ratio will have bands on the left and right sides of the screen.
  - Programs broadcasted in HD formats (720p and 1080i) with 4:3 content will commonly have black bands on the left and right sides of the screen which are added by the broadcaster.
  - [Auto Wide] will not expand the picture when the black bands on the sides of the screen are added by the broadcaster. You can manually set [Wide Mode] to [Wide Zoom] or [Zoom], which will remain in effect until you change the channel/input or manually change the [Wide Mode] setting again.
- 

Certain programs on DVD or other digital sources display a loss of detail, especially during fast-motion or dark scenes.

- Less detail than usual or artifacts (small blocks, dots or pixelation) may appear on the screen, due to the digital compression of the source content used by certain digital broadcasts and DVDs. The degree of visible artifacts depends on the clarity and resolution of the TV.
- 

[▲ Return to Top](#)

How to Use i-Manual

“BRAVIA” TV Features

Watching TV

Settings/Home Menu

Using Other  
Equipment/Internet

Parts Description

Troubleshooting

Bookmarks

Index

[→ i-Manual online map](#)

## Picture Symptoms: TV Program

- You cannot receive any channels.
- You cannot receive or select channels.
- Some digital cable channels are not displayed.
- Broadcast HD formats have poor quality.
- Ghosting or double images appear.
- Only snow noise or black picture appears on the screen.
- Noisy picture.
- Photo images appear small on the screen.
- Photo images or folders take time to display.
- Some channels are blank.
- You cannot view digital channels.

You cannot receive any channels.

- Check the antenna/cable connection.
- Make sure the [Cable/Antenna] setting is correct for your TV signal source.
- If using CATV STB, refer to its instruction manual for installation.

You cannot receive or select channels.

- Perform [Auto Program] to add receivable channels that are not present in the TV's memory.
- To receive or select cable channels, make sure that signal type in the channel settings is set to [Cable].
- To receive or select channels by antenna, make sure signal type is set to [Antenna].

Some digital cable channels are not displayed.

- Certain cable companies have limitations on the broadcast of digital cable channels. Check with your cable company for more information.
- The digital cable channel may be set to [Hidden] in [Show/Hide Channels].

Broadcast HD formats have poor quality.

- Content and signal quality are regulated by the signal provider. Many HD channels and content are actually upscaled versions of standard-definition broadcasts. The picture is affected by the quality of the signal received, which varies between channel and program.

Ghosting or double images appear.

- Check cable or antenna connections.
- Check the antenna location and direction.

- Set [Motionflow] to [Standard] or [Off]. (For [Motionflow] compatible models only.)
- 

Only snow noise or black picture appears on the screen.

- Check if the antenna is broken or bent.
  - Check if the antenna has reached the end of its serviceable life (3-5 years in normal use, 1-2 years at the seaside).
- 

Noisy picture.

- Make sure that the antenna is connected using a 75-ohm coaxial cable.
  - Keep the antenna cable away from other connecting cables.
  - To avoid TV interference, make sure to use an undamaged antenna cable.
- 

Photo images appear small on the screen.

- Photo images may not be displayed in full screen depending on the resolution or aspect ratio of the file.
- 

Photo images or folders take time to display.

- Depending on the image dimension, file size, and number of files in a folder, some photo images or folders take time to display.
  - The first time a camera is connected to the TV via USB cable, it may take up to a couple of minutes for the photos to display.
- 

Some channels are blank.

- The channel is for scrambled/subscription service only. Subscribe to a pay TV service.
  - The channel is used only for data (no picture or sound).
  - Contact the broadcaster for transmission details.
- 

You cannot view digital channels.

- Ask a local installer if digital transmissions are provided in your area.
  - Upgrade to a higher gain antenna.
- 

[▲ Return to Top](#)



How to Use i-Manual

“BRAVIA” TV Features

Watching TV

Settings/Home Menu

Using Other  
Equipment/Internet

Parts Description

**Troubleshooting**

Bookmarks

Index

[→ i-Manual online map](#)

## Picture Symptoms: 3D

- 3D pictures are not displayed. 3D effect is weak.
- A 3D Sweep Panorama photo cannot be displayed.
- Black bars appear on both sides of the screen when watching 3D pictures.
- 3D display automatically switches on when 3D signal is detected.
- The message [3D signal has been detected] automatically appears when 3D signal is detected.
- 3D Glasses do not fit properly.
- LED indicator on the 3D Glasses flashes.
- You cannot turn the 3D Glasses on.
- You cannot charge the 3D Glasses. (Applies only to TDG-BR250/BR200.)

3D pictures are not displayed. 3D effect is weak.

- Be sure that there are no obstacles between the 3D Sync Transmitter and the 3D Glasses.
- Replace the battery in the 3D Glasses, or charge the battery if the 3D Glasses have a rechargeable battery.
- Be sure that the 3D Glasses are powered on.
- If two pictures are displayed side-by-side, press 3D to display the 3D Menu, then press 3D repeatedly until [Side-by-Side] appears. If two pictures are displayed one above the other, press 3D to display the 3D Menu, then press 3D repeatedly until [Over-Under] appears.
- If the [3D Menu] setting screen appears and 3D pictures are not displayed, turn off the device that plays 3D content and turn it on again.
- Perceived 3D effect may vary from person to person.
- 3D effect may be less pronounced if ambient temperature is low.
- 3D effect may be less pronounced and the display color will be shifted if you lie down or tilt your head.

A 3D Sweep Panorama photo cannot be displayed.

- Displaying a 3D Sweep Panorama photo is available only when [Slideshow Effect] is set to [Simple]. To confirm the setting, press OPTIONS, then select [Playback Method] → [Slideshow Effect] → [Simple].
- Displaying a 3D Sweep Panorama photo via the DLNA-certified media server is not available.

Black bars appear on both sides of the screen when watching 3D pictures.

- Black bars appear on both sides of the screen in order to process 3D signals for the simulated 3D display mode or when adjusting the depth of 3D pictures in [3D Depth Adjustment].

3D display automatically switches on when 3D signal is detected.

- Set to manually turn the 3D display on or off. Press HOME, then select  → [Picture & Display] → [3D Settings] → [Auto 3D] → [Off].

The message [3D signal has been detected] automatically appears when 3D signal is detected.

- Deactivate the [3D Signal Notification] setting. Press HOME, then select  → [Picture & Display] → [3D Settings] → [3D Signal Notification] → [Off].

---

3D Glasses do not fit properly.

(The following adjustments apply only to TDG-BR100.)

- Set both the switches on either side for a comfortable fit. Close the temple arms slightly inwards to set the switch. **(1)**
- Bend (adjust) the temple frames for a comfortable fit. **(2)**
- Adjust the nose pad for your nose. **(3)**

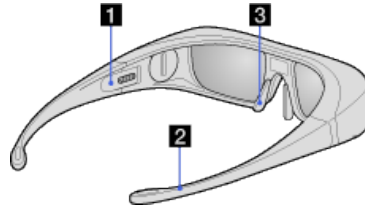

---

LED indicator on the 3D Glasses flashes.

(The following illustration shows TDG-BR100.)

- Flashes every few seconds: Indicates the glasses are powered on.
- Flashes 3 times: Indicates the glasses have been powered off. The glasses turn off if you hold the power button down for 2 seconds, or if no signal from the 3D Sync Transmitter is detected for more than 5 minutes.
- Flashes 3 times every 3 seconds: Indicates the battery capacity is almost running out. Replace the battery, or charge the battery if the 3D Glasses have a rechargeable battery.



---

You cannot turn the 3D Glasses on.

- Replace the battery. (Applies only to TDG-BR100/BR50. TDG-BR100 is used as an example in the following instructions and illustrations.)
  - Open the battery cover using a coin, etc.
  - Push the edge of the battery and remove it at an angle.
  - Insert a battery (CR2032) with its positive (+) side facing up.
  - Close the battery cover using a coin, etc.
  - Make sure the cover is closed.

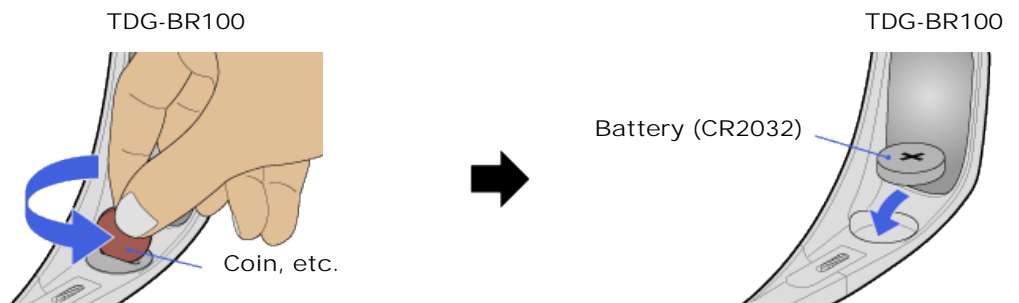

- When opening or closing the battery cover, be sure to insert a coin, etc., into the slot.

---

---

You cannot charge the 3D Glasses. (Applies only to TDG-BR250/BR200.)

- Check if the TV is turned on. The 3D Glasses cannot be charged if the TV is in standby mode.
  - Check if the 3D Glasses are turned off. The 3D Glasses must be turned off to charge.
  - Check if the USB cable is connected properly.
- 

[▲ Return to Top](#)

How to Use i-Manual

“BRAVIA” TV Features

Watching TV

Settings/Home Menu

Using Other  
Equipment/Internet

Parts Description

Troubleshooting

Bookmarks

Index

[→ i-Manual online map](#)

## Picture Symptoms: Connected Equipment

- [No picture from some video sources.](#)
- [Poor picture quality on PC input.](#)

No picture from some video sources.

- Check the connection between the optional video equipment and TV.
- Press INPUT.
- Press HOME, then select  → the desired input.

Poor picture quality on PC input.

- Adjust the resolution.
- Adjust [Pitch] and [Phase].

[▲ Return to Top](#)

How to Use i-Manual

“BRAVIA” TV Features

Watching TV

Settings/Home Menu

Using Other  
Equipment/Internet

Parts Description

Troubleshooting

Bookmarks

Index

[→ i-Manual online map](#)

## Sound Symptoms

- [No sound but good picture.](#)
- [Audio noise.](#)
- [No audio or low audio with home theater system.](#)

### No sound but good picture.

- Check the volume control.
- Press MUTING or VOL + to cancel muting.
- Set [Speakers] to [TV Speakers] in the [Sound] setting. If it is set to [Audio System], sound is not output from the TV's speakers regardless of the TV's volume control.
- When using HDMI input with Super Audio CD or DVD-Audio, DIGITAL AUDIO OUT (OPTICAL) may not provide an audio signal.

### Audio noise.

- Make sure that the antenna is connected using a 75-ohm coaxial cable.
- Keep the antenna cable away from other connecting cables.
- To avoid TV interference, make sure to use an undamaged antenna cable.
- Adjust [Analog Fine Tune] to improve sound for analog reception.

### No audio or low audio with home theater system.

- Set [Speakers] to [Audio System] in the [Sound] setting.
- Set [Audio Out] to [Fixed] in the [Sound] setting.

[▲ Return to Top](#)

How to Use i-Manual

“BRAVIA” TV Features

Watching TV

Settings/Home Menu

Using Other  
Equipment/Internet

Parts Description

Troubleshooting

Bookmarks

Index

[→ i-Manual online map](#)

## Wireless Network Connection Symptoms

- Sometimes video streaming quality is poor when using the wireless LAN.
- Wireless LAN connection fails or radio reception conditions are poor.

Sometimes video streaming quality is poor when using the wireless LAN.

- The wireless network connection quality varies depending on the distance or obstacles (e.g. wall) between the TV/USB Wireless LAN Adapter and the wireless router (access point), environment interference, and quality of the wireless router (access point). If using USB Wireless LAN Adapter, it is suggested to use a wireless router (access point) supporting 5GHz operation for video streaming and place it closer to the USB Wireless LAN Adapter (not applicable for models with built-in wireless LAN device).

Wireless LAN connection fails or radio reception conditions are poor.

- Check the installation location of the TV and wireless router (access point). Signal condition may be affected for the following reasons.
  - Other wireless devices, microwaves, fluorescent lights, etc., are placed nearby.
  - There are floors or walls between the wireless router (access point) and TV.If the problem persists even after checking the above, try making a wired LAN connection.
- When using a USB Wireless LAN Adapter, move it to avoid signal interference by using an extension cable with base unit (optional accessory).

[▲ Return to Top](#)

How to Use i-Manual

“BRAVIA” TV Features

Watching TV

Settings/Home Menu

Using Other  
Equipment/Internet

Parts Description

Troubleshooting

Bookmarks

Index

[→ i-Manual online map](#)

## Internet Video Symptoms

- [Poor picture on “BRAVIA” Internet Video.](#)
- [Small picture on “BRAVIA” Internet Video.](#)
- [Certain Internet video content displays a loss of detail, especially during fast-motion or dark scenes.](#)
- [Good picture quality but no sound on Internet video content.](#)
- [You do not see many videos in the Internet Video Guide.](#)

Poor picture on “BRAVIA” Internet Video.

- Quality depends on the original video provided by the video content provider and your connection bandwidth.

Small picture on “BRAVIA” Internet Video.

- Use the color buttons to zoom in and out.

Certain Internet video content displays a loss of detail, especially during fast-motion or dark scenes.

- Video quality and picture size depend on broadband speed and delivery by content providers.

Good picture quality but no sound on Internet video content.

- Quality depends on the original content provided by the video content provider and your connection bandwidth.
- Due to the nature of Internet video, not all videos will contain sound.

You do not see many videos in the Internet Video Guide.

- Press OPTIONS, then select categories to view more content.
- Check the [Parental Lock] ratings on the TV; some Internet content may be blocked based on the rating.

[▲ Return to Top](#)

How to Use i-Manual

"BRAVIA" TV Features

Watching TV

Settings/Home Menu

Using Other  
Equipment/Internet

Parts Description

Troubleshooting

Bookmarks

Index

[→ i-Manual online map](#)

## Internet Widget Symptoms

- [Widgets are inaccessible.](#)

Widgets are inaccessible.

- Check that the LAN cable or AC power cord of the router/modem\* has been connected properly.  
\* Your router/modem must be set in advance to connect to the Internet. Contact your Internet service provider for router/modem settings.
- Try using Widgets later. The Widget content provider's server may be out of service.

[▲ Return to Top](#)



How to Use i-Manual

“BRAVIA” TV Features

Watching TV

Settings/Home Menu

Using Other  
Equipment/Internet

Parts Description

Troubleshooting

Bookmarks

Index

[→ i-Manual online map](#)

## Home Network (DLNA) Symptoms

- [Your TV cannot connect to the server.](#)
- [A message appears stating that the TV cannot connect to your network.](#)
- [DLNA-certified media server is inaccessible although it is listed under \[Media\] in the Home Menu.](#)
- [Some photo, music, video files in the connected USB device or DLNA-certified media server are not displayed.](#)
- [When using the renderer function, music files cannot be played back.](#)

Your TV cannot connect to the server.

- Check the LAN cable or connection to your server and your TV.
- Check if your network is properly configured on your TV.

A message appears stating that the TV cannot connect to your network.

- Check the current network settings. Press HOME, then select → [Network] → [Network Setup] → [View Network Status]. If all of your network settings are 0.0.0.0, your server may not be connected properly. Check your network connections and/or server's instruction manual for connection information.
- Reconfigure your network settings.
- If the LAN cable is connected to an active server and the TV has acquired an IP address, check your DLNA-certified media server's connections and configurations.



- Your IP address configuration can be viewed by selecting the [View Network Status] option.

DLNA-certified media server is inaccessible although it is listed under [Media] in the Home Menu.

- Check your LAN cable/connection or your server connections. The TV may have lost connection with the server.
- Perform [Media Server Troubleshooting] to check if your media server is properly communicating with the TV. Press HOME, then select → [Network] → [Home Network Setup] → [Media Server Troubleshooting].

Some photo, music, video files in the connected USB device or DLNA-certified media server are not displayed.

- Unsupported files may not be displayed.
- The accessible file or folder limit in a directory is 1,000 for USB and 30,000 for a DLNA-certified media server. This limit includes non-supported files or just folders. Files or folders are

populated based on their timestamps. Photo, music files or folders exceeding the limit will not be displayed.

---

When using the renderer function, music files cannot be played back.

- Some applications display a photo file pre-installed in the PC simultaneously with music playback when using the renderer function. Depending on the pre-installed photo file, music playback may not be possible, but may become possible by changing the photo file.
- 

[▲ Return to Top](#)

How to Use i-Manual

“BRAVIA” TV Features

Watching TV

Settings/Home Menu

Using Other  
Equipment/Internet

Parts Description

Troubleshooting

Bookmarks

Index

→ [i-Manual online map](#)

## Other Symptoms

- [TV turns off automatically.](#)
- [TV screen feels warm.](#)
- [You cannot find a connected “BRAVIA” Sync HDMI device.](#)
- [You cannot control a second AV receiver.](#)
- [Remote control does not operate.](#)

TV turns off automatically.

- Check if [Sleep Timer] is activated.
- Check if [Auto Shut-off] in [Eco] is activated.
- Check if [Presence Sensor] in [Eco] is activated.

TV screen feels warm.

- Due to the thin profile of this television, the heat generated by the LCD panel backlight and supporting electronics will be more noticeable. This is normal operation and not a cause for concern.

You cannot find a connected “BRAVIA” Sync HDMI device.

- Make sure that [Control for HDMI] is set up on both the TV and the optional equipment compatible with “BRAVIA” Sync.

You cannot control a second AV receiver.

- Only one AV receiver may be used with the “BRAVIA” Sync and “Control for HDMI” functions at one time.
- The buttons on the remote control do not operate equipment with the “Control for HDMI” function.

Remote control does not operate.

- Press a button on the TV to determine if the problem is with the remote control or not.
- Check the polarity of the batteries or replace the batteries.

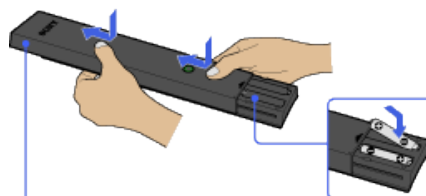

Slide the cover to open.

- Point the remote control at the remote control sensor located at the front of the TV.
  - Keep the remote control sensor area clear from obstacles.
  - Fluorescent light can interfere with remote control operation; try turning off any fluorescent light.
- 

[▲ Return to Top](#)

---

How to Use i-Manual

“BRAVIA” TV Features

Watching TV

Settings/Home Menu

Using Other  
Equipment/Internet

Parts Description

Troubleshooting

**Bookmarks**

Index

[→ i-Manual online map](#)

## How to Use Bookmarks

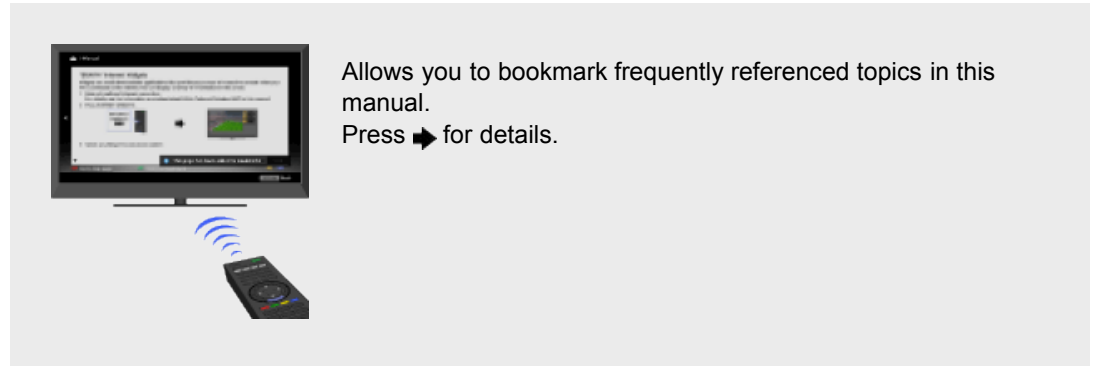

This feature allows you to bookmark frequently referenced topics in this manual.  
In the page to bookmark, press the corresponding color button.

### Accessing bookmarked pages

The bookmarked pages will appear at the bottom of the topic list. You can access bookmarked pages in the same way as accessing topics in general.

### Removing Bookmarks

In a bookmarked page, press the corresponding color button.

[▲ Return to Top](#)

How to Use i-Manual

“BRAVIA” TV Features

Watching TV

Settings/Home Menu

Using Other  
Equipment/Internet

Parts Description

Troubleshooting

Bookmarks

Index

[→ i-Manual online map](#)

## Parental Lock

---

Sets an age restriction for viewing, or blocks specific channels. To view any rated program you specify or any blocked channel, enter the correct password.



- For the password, refer to Troubleshooting in the paper manual supplied with this TV.
- [Country], [Rating] and [Unrated] are available depending on your region/country.

---

### Password

Sets a four-digit password.

---

### Country

Enables selection of your location to change the rating system.

---

### Rating

Sets the rating permission.

---

### Downloadable U.S. Rating/Digital Rating

(Item name differs depending on your region/country.)

Customizes [Parental Lock] with downloadable digital rating.

---

### Unrated

Allows or blocks programs or movies that are broadcast without a rating.

---

### Channel Block/Analog Channel Block

(Item name differs depending on your region/country.)

Blocks specific channels regardless of program ratings. To view any blocked channel, enter the correct password.

---

[▲ Return to Top](#)

How to Use i-Manual

“BRAVIA” TV Features

Watching TV

Settings/Home Menu

Using Other  
Equipment/Internet

Parts Description

Troubleshooting

Bookmarks

Index

[➡ i-Manual online map](#)

## Auto Program

---

Automatically scans for all available channels and stores them in the TV.

You can run [Auto Program] after moving to a new residence, changing service providers, or to search for newly launched channels.

[▲ Return to Top](#)

How to Use i-Manual

“BRAVIA” TV Features

Watching TV

Settings/Home Menu

Using Other  
Equipment/Internet

Parts Description

Troubleshooting

Bookmarks

Index

[➡ i-Manual online map](#)

## Initial Setup

---

Runs the initial setup that appeared when you first connected the TV. Follow the instructions on the screen. This setting is useful when you change the settings after moving to a new residence, or when you search for newly launched channels.

[▲ Return to Top](#)



How to Use i-Manual

“BRAVIA” TV Features

Watching TV

**Settings/Home Menu**

Using Other  
Equipment/Internet

Parts Description

Troubleshooting

Bookmarks

Index

[➡ i-Manual online map](#)

## Recommendation

---

Searches for and shows programs you may like under [Recommendations] in the Home Menu.

[▲ Return to Top](#)

How to Use i-Manual

“BRAVIA” TV Features

Watching TV

Settings/Home Menu

Using Other  
Equipment/Internet

Parts Description

Troubleshooting

Bookmarks

Index

[➔ i-Manual online map](#)

## Clock/Timers

---

### Current Time

Sets the current time. When the TV has received the time from the broadcast signal, the clock cannot be manually set.

---

### Timer

Turns on the TV from standby mode at the time you set.

---

### Sleep Timer

Turns the TV off after a preset time.



- When you turn off the TV and turn it on again, [Sleep Timer] is reset to [Off].
- 

[▲ Return to Top](#)

How to Use i-Manual

“BRAVIA” TV Features

Watching TV

Settings/Home Menu

Using Other  
Equipment/Internet

Parts Description

Troubleshooting

Bookmarks

Index

[➔ i-Manual online map](#)

## Manage Inputs

---

Assigns an icon or name to external equipment.

Select [Auto] to display icons or names only when the equipment is connected, or [Always] to display regardless of connection status.



- For a PC connection, the icon and label cannot be set.

[▲ Return to Top](#)

How to Use i-Manual

“BRAVIA” TV Features

Watching TV

Settings/Home Menu

Using Other  
Equipment/Internet

Parts Description

Troubleshooting

Bookmarks

Index

[➡ i-Manual online map](#)

## Video 2/Component Selection

---

Switches between [Component] and [Video 2].

If you select [Auto], the TV detects the terminal connection signal and switches to either [Component] or [Video 2].



- You cannot use [Component] and [Video 2] at the same time.

[▲ Return to Top](#)

How to Use i-Manual

“BRAVIA” TV Features

Watching TV

Settings/Home Menu

Using Other  
Equipment/Internet

Parts Description

Troubleshooting

Bookmarks

Index

[→ i-Manual online map](#)

## Eco

---

Changes the settings related to power consumption.



- Energy efficiency reduces power consumption and thus saves money by reducing electricity bills.

### Power Saving

Reduces power consumption by adjusting the TV backlight. When you select [Picture Off], only sound remains.

### Presence Sensor

When no viewer is detected in front of the TV for a preset time, the picture automatically turns off, while leaving only the TV sound on. Additionally, after 30 minutes in picture off mode, the TV will switch to standby mode.

### Idle TV Standby

Turns the TV off after it has been idle for a preset time.

### Light Sensor

Optimizes the picture settings according to the ambient lighting.



- [Light Sensor] is available depending on the TV model.

### Auto Shut-off

Turns the TV off when no input signal is detected for 15 minutes.

[▲ Return to Top](#)

How to Use i-Manual

“BRAVIA” TV Features

Watching TV

Settings/Home Menu

Using Other  
Equipment/Internet

Parts Description

Troubleshooting

Bookmarks

Index

[→ i-Manual online map](#)

## Picture Adjustments

### Setting Memory

Applies custom picture settings to the current input or to common memory shared by other inputs.



- Available inputs may vary depending on your region/country.

### Picture Mode

[Vivid] : Enhances picture contrast and sharpness.

[Standard] : Provides standard picture for basic home use.

[Custom] : Stores your preferred settings.

[Cinema 1] : Provides film-based content for a theater-like environment.

[Cinema 2] : Provides film-based content for basic home use.

[Sports] : Optimizes picture quality for viewing sports.

[Game-Standard] : Provides standard pictures suitable for games.

[Game-Original] : Adjusts the game picture according to your preference.

[Graphics] : Optimizes picture quality for viewing graphics.

[Photo-Vivid] : Enhances contrast, sharpness, and color of photographs.

[Photo-Standard] : Optimizes picture quality for viewing photographs.

[Photo-Original] : Enhances the visual warmth of photographs.

[Photo-Custom] : Adjusts the detailed settings for viewing photographs and stores your preferred settings.

[Animation] : Optimizes picture quality for viewing animations.

### Reset

Resets all the [Picture Adjustments] settings to the factory settings excluding [Setting Memory], [Picture Mode] and [Advanced Settings].

### Backlight

Adjusts the brightness of the backlight. Reducing the brightness of the screen will reduce the power consumption.

### Picture

Adjusts picture contrast.

### Brightness

Adjusts the brightness of the picture.

### Color

Adjusts color intensity.

### Hue

Adjusts green and red tones.



- [Hue] is available depending on color system.

---

### Color Temperature

Adjusts the whiteness of the picture.

[Cool] : Gives white colors a bluish tint.

[Neutral] : Gives white colors a neutral tint.

[Warm 1]/[Warm 2] : Gives white colors a reddish tint. [Warm 2] gives a redder tint than [Warm 1].

---

### Sharpness

Adjusts sharpness of the picture.

---

### Noise Reduction

[Auto] : Automatically reduces picture noise.

[High]/[Medium]/[Low] : Modifies the effect of noise reduction.

[Off] : Turns off [Noise Reduction].

---

### MPEG Noise Reduction

[Auto] : Automatically reduces noise in MPEG-compressed videos.

[High]/[Medium]/[Low] : Reduces noise in MPEG-compressed videos.

[Off] : Turns off [MPEG Noise Reduction].

---

### Dot Noise Reduction

[Auto] : Automatically reduces dot noise around objects on the screen.

[Off] : Turns off [Dot Noise Reduction].

---

### Reality Creation

Adjusts detail and noise for a realistic picture.



- [Reality Creation] is available depending on the TV model.
- 

### Resolution

Adjusts detail and clarity of the picture.



- [Resolution] is available depending on the TV model.
- 

### Noise Filtering

Adjusts to reduce noise of the picture.



- [Noise Filtering] is available depending on the TV model.
- 

### Smooth Gradation

Creates smooth gradations on flat surfaces of the picture.



- [Smooth Gradation] is available depending on the TV model.
- 

### Motionflow

[Smooth] : Provides smoother picture movement, such as for film-based content.

[Standard] : Provides smoother picture movement for standard use.

[Clear] : Reduces motion blur while maintaining brightness for high-speed picture content.

[Clear Plus] : Reduces motion blur for high-speed picture content.

[Off] : Use this setting if [Smooth], [Standard], [Clear] or [Clear Plus] results in picture noise.



- Depending on the picture content, you may not see the effect visually even if you have changed the settings.

---

### CineMotion

[Auto 1] : Provides smoother picture movement than the original film-based content. Use this setting for standard use.

[Auto 2] : Displays film-based content with picture expression close to the original by applying a film-specific process.

[Off] : Turns off [CineMotion].



- If the image contains irregular signals or too much noise, this setting is automatically turned off even if [Auto 1] or [Auto 2] is selected.

---

### Advanced Settings

Sets [Picture Adjustments] settings in more detail.

[Reset] : Resets all the advanced settings to the factory settings.

[Black Corrector] : Enhances black areas of the picture for stronger contrast.

[Adv. Contrast Enhancer] : Adjusts [Backlight] and [Picture] by judging the brightness of the screen. This setting is effective for dark images and scenes.

[Gamma] : Adjusts the balance between bright and dark areas of the picture.

[LED Dynamic Control] : Optimizes contrast by adjusting brightness in individual sections of the screen.

[Auto Light Limiter] : Reduces glare such as in scenes where the entire screen is white.

[Clear White] : Emphasizes white colors.

[Live Color] : Makes colors more vivid.

[White Balance] : Adjusts the level of each color.

[Detail Enhancer] : Enhances the details of the picture.

[Edge Enhancer] : Enhances the edges of the picture.

[Skin Naturalizer] : Makes the texture of skin smoother.

[i/p Conversion Preference] : Sets the priority for optimizing quality or display speed of the picture. Selecting [Speed] reduces the delay between an operation of a game controller/PC mouse and the TV's response.



- [Speed] in the [i/p Conversion Preference] setting does not function for progressive signals.
- [LED Dynamic Control] is available depending on the TV model.

---

[▲ Return to Top](#)



How to Use i-Manual

“BRAVIA” TV Features

Watching TV

Settings/Home Menu

Using Other  
Equipment/Internet

Parts Description

Troubleshooting

Bookmarks

Index

[→ i-Manual online map](#)

## Pro Picture Setup



- [SBM] and [Color System] are available depending on your TV model/region/country.

### Color Matrix

Reproduces the color-difference signals. It is recommended to leave this at the factory default setting.

### HDMI Dynamic Range

Produces natural color by changing the luminance tone reproduction of HDMI input color signals. It is recommended to select [Auto], which changes the tone reproduction automatically, for standard use. Select [Full] if black/white colors appear smeared.

### SBM

Creates gradations using Super Bit Mapping technology.

### Color System

Sets the color system according to the input signal from the input source.

[▲ Return to Top](#)

How to Use i-Manual

“BRAVIA” TV Features

Watching TV

Settings/Home Menu

Using Other  
Equipment/Internet

Parts Description

Troubleshooting

Bookmarks

Index

[→ i-Manual online map](#)

## Scene Select

---

Optimizes picture and sound quality by selecting the following items.

---

### Auto

Automatically optimizes picture and sound quality according to the input source.

---

### General

Optimizes picture and sound quality for general content.

---

### Cinema

Optimizes picture scenes and sound just like those in a theater.

---

### Sports

Presents realistic pictures and sound just like those in a stadium.

---

### Music

Lets you experience dynamic and clear sound just like at a concert.

---

### Animation

Lets you enjoy watching an animation with superb picture quality.

---

### Photo

Reproduces the texture and color of a printed photo.



- [Photo] is available only when the input signal is 1080i/p (except broadcast signal).

### Game

Broadens your game-playing experience with superb picture and sound quality.

---

### Graphics

Eases prolonged monitor viewing with clearer detailed pictures.

---

[▲ Return to Top](#)

How to Use i-Manual

“BRAVIA” TV Features

Watching TV

Settings/Home Menu

Using Other  
Equipment/Internet

Parts Description

Troubleshooting

Bookmarks

Index

[→ i-Manual online map](#)

## Screen (for inputs other than a PC)

### Setting Memory

Applies custom screen settings to the current input or to common memory shared by other inputs.



- Available inputs may vary depending on your region/country.

### Wide Mode

[Wide Zoom] : Fills the screen with minimum distortion.

[Normal] : Displays the 4:3 picture in its original size. Side bars are shown to fill the 16:9 screen.

[Full] : Enlarges the picture horizontally to fill the screen when the input signal is 4:3.

[Zoom] : Displays the cinemascope (letter box format) picture in the correct proportion.

[Caption] : Enlarges the picture horizontally to fill the 16:9 screen, while fitting captions in the screen.

### Auto Wide

Automatically changes [Wide Mode] to match the input signal.

### 4:3 Default

Sets the default screen format for a 4:3 input signal.

### Auto Display Area

Automatically adjusts the picture to the most appropriate display area.

### Display Area

[Full Pixel] : Displays the original picture when parts of the picture are cut.

[+1] : Displays the picture using the TV's maximum display area.

[Normal] : Displays the recommended size picture.

[-1] : Enlarges the picture.



- [Full Pixel] is available only when the input signal is 1080i/1080p and [Wide Mode] is set to [Full].

### Screen Position

Adjusts the vertical position and horizontal position of the picture.

### Vertical Size

Adjusts the vertical size of the picture.

[▲ Return to Top](#)

How to Use i-Manual

"BRAVIA" TV Features

Watching TV

Settings/Home Menu

Using Other  
Equipment/Internet

Parts Description

Troubleshooting

Bookmarks

Index

[→ i-Manual online map](#)

## Screen (for PC input)

---

### Auto Adjust

Automatically adjusts the display position, and phase of the picture in PC mode.



- [Auto Adjust] may not work well with certain input signals. In such cases, manually adjust [Phase], [Pitch], [H Center], and [V Center].

### Reset

Resets all PC screen settings to factory settings.

### Phase

Adjusts the phase when the screen flickers.

### Pitch

Adjusts the pitch when the picture has unwanted vertical stripes.

### H Center

Adjusts the horizontal position of the picture.

### V Center

Adjusts the vertical position of the picture.

### Wide Mode

[Normal] : Displays the original picture.

[Full 1] : Enlarges the picture to fill the display area maintaining the original picture.

[Full 2] : Enlarges the picture to fill the display area.

[▲ Return to Top](#)

How to Use i-Manual

“BRAVIA” TV Features

Watching TV

**Settings/Home Menu**

Using Other  
Equipment/Internet

Parts Description

Troubleshooting

Bookmarks

Index

[➔ i-Manual online map](#)

## Audio Out

---

### Fixed

Adjusts the volume using the connected audio system's remote control.

---

### Variable

Adjusts the volume with the TV's remote control, when using an external audio system.

---

[▲ Return to Top](#)

How to Use i-Manual

“BRAVIA” TV Features

Watching TV

Settings/Home Menu

Using Other  
Equipment/Internet

Parts Description

Troubleshooting

Bookmarks

Index

[➡ i-Manual online map](#)

## Headphone/Audio Out

Sets the sound output to headphones or external audio system connected to the TV.



- Disconnect headphones from the TV when you select [Audio Out].

[▲ Return to Top](#)

How to Use i-Manual

“BRAVIA” TV Features

Watching TV

Settings/Home Menu

Using Other  
Equipment/Internet

Parts Description

Troubleshooting

Bookmarks

Index

[→ i-Manual online map](#)

## Sound Adjustments

### Setting Memory

Applies custom sound settings to the current input or to common memory shared by other inputs.



- Available inputs may vary depending on your region/country.

### Sound Mode

[Dynamic] : Enhances the treble and bass sound to make sound clear.

[Standard] : Provides natural sound.

[Clear Voice] : Makes voice clearer by lowering background sound.

[Custom] : Customizes sound settings.



- [Custom] is available depending on your region/country.

### Reset

Resets all the [Sound Adjustments] settings to the factory settings excluding [Setting Memory] and [Sound Mode].

### Treble

Adjusts higher-pitched sounds.

### Bass

Adjusts lower-pitched sounds.

### Balance

Emphasizes the left or right speaker.

### Surround

[S-Force Front Surround] : Virtually reproduces realistic sound.

[Sports] : Delivers surround effects that make you feel like you are watching a live sports event.

[Music] : Delivers surround effects that make you feel like you are in a music hall.

[Cinema] : Delivers surround effects just like the high-grade audio systems found in movie theaters.

[Game] : Delivers surround effects for a virtual game-playing experience.

[Simulated Stereo] : Adds a surround-like effect to monaural programs.

[Off] : Turns off [Surround].



- [Simulated Stereo] is available depending on your region/country.
- Before selecting [Surround], be sure to set menu items in [Scene Select] according to your target program type to obtain surround effects.
- Sound will be interrupted if you change the [Surround] setting while listening to Dolby Digital

multi-channel audio.

---

#### S-Force Front Surround 3D

Virtually generates 3 dimensional sound.



- [S-Force Front Surround 3D] is not available when [Surround] is set to [Off] or [Simulated Stereo].

---

#### Sound Enhancer

Reproduces clear sound by complementing high-frequency bands.

---

#### Equalizer

Adjusts the level of the low and high bands.



- [Equalizer] is available depending on your region/country.

---

#### Advanced Auto Volume

Keeps volume level constant across all programs and advertisements. (Advertisements tend to be louder than programs.)

---

#### Volume Offset

Adjusts the current volume level relative to other inputs, when [Setting Memory] is set to the current input.

---

[▲ Return to Top](#)



How to Use i-Manual

“BRAVIA” TV Features

Watching TV

Settings/Home Menu

Using Other  
Equipment/Internet

Parts Description

Troubleshooting

Bookmarks

Index

[➔ i-Manual online map](#)

## Speakers

Sets the sound output to [TV Speakers] or [Audio System].



- To use multi-channel audio, connect to an external audio system compatible with Dolby Digital using an optical cable, and select [Audio System].
- [Audio System] must be selected to listen to 5.1 multi-channel audio.

[▲ Return to Top](#)

How to Use i-Manual

“BRAVIA” TV Features

Watching TV

**Settings/Home Menu**

Using Other  
Equipment/Internet

Parts Description

Troubleshooting

Bookmarks

Index

[➡ i-Manual online map](#)

## Startup Sound

---

Turns the TV start-up sound on or off.

[▲ Return to Top](#)

How to Use i-Manual

"BRAVIA" TV Features

Watching TV

Settings/Home Menu

Using Other  
Equipment/Internet

Parts Description

Troubleshooting

Bookmarks

Index

[→ i-Manual online map](#)

## Connecting HDMI Equipment

HDMI (High-Definition Multimedia Interface) is an uncompressed all-digital audio/video interface between the TV and any HDMI-compatible A/V equipment. In addition, if you connect equipment that is compatible with "Control for HDMI," you can control it by simply using the TV's remote control.

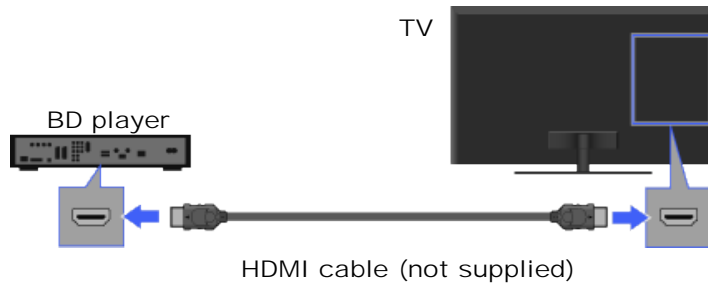

- Be sure to use an authorized HDMI cable bearing the HDMI logo.
- If the equipment has a DVI jack, connect it to the HDMI (with AUDIO IN) port through a DVI - HDMI adapter interface (not supplied), and connect the equipment's audio out jacks to the PC/HDMI AUDIO IN.

[▲ Return to Top](#)

How to Use i-Manual

"BRAVIA" TV Features

Watching TV

Settings/Home Menu

Using Other  
Equipment/Internet

Parts Description

Troubleshooting

Bookmarks

Index

→ i-Manual online map

## Connecting to a Home Network

You can enjoy various content (e.g. photo/music/video files) stored on DLNA-certified media servers. The home network feature allows you to enjoy network content in other rooms.

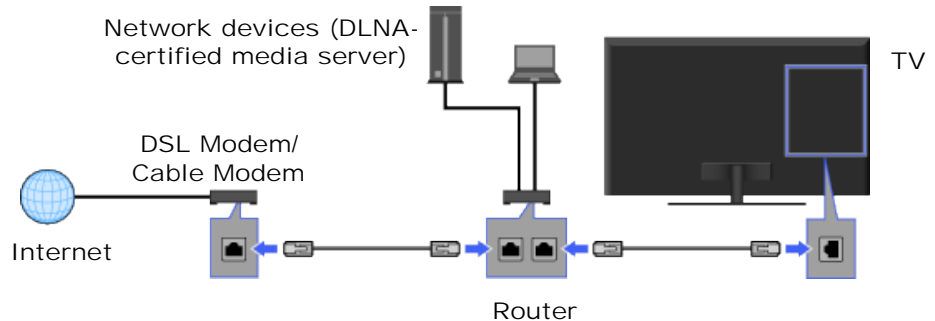

## Playing photos/music/videos

1. Press HOME, then select → [Photos], [Music] or [Videos] → the desired media server.
2. Select files or folders to play from the list.



- The server is required to be DLNA-certified.
- Files from a network device need to be in the following formats:
  - Still images: JPEG
  - Music: MP3, linear PCM, WMA
  - Video: AVCHD, MPEG2, MPEG1, MP4 (AVC), MP4 (MPEG4), WMV
- Depending on the file, playback may not be possible even when using the supported formats.
- Only the panoramic JPEG files in the following horizontal/vertical sizes can be scrolled. (If the JPEG file is edited on a PC, etc., scroll may not be possible.)
  - For horizontal scroll: 4912/1080, 7152/1080, 3424/1920, 4912/1920, 12416/1856, 8192/1856, 5536/2160, 3872/2160, 10480/4096
  - For vertical scroll: 1080/4912, 1080/7152, 1920/3424, 1920/4912, 1856/12416, 1856/8192, 2160/5536, 2160/3872, 4096/10480
- For 3D-compatible models, displaying a 3D Sweep Panorama photo via the DLNA-certified media server is not available.
- Scrolling a panoramic photo is available only when [Slideshow Effect] is set to [Simple]/[Crossfade]. To confirm the setting, press OPTIONS, then select [Playback Method] → [Slideshow Effect] → [Simple]/[Crossfade].

▲ Return to Top

How to Use i-Manual

"BRAVIA" TV Features

Watching TV

Settings/Home Menu

Using Other  
Equipment/Internet

Parts Description

Troubleshooting

Bookmarks

Index

[→ i-Manual online map](#)

## Wired LAN

A wired LAN connection allows you to access the Internet and your home network. Connect a LAN cable to your TV, then perform the network setup.

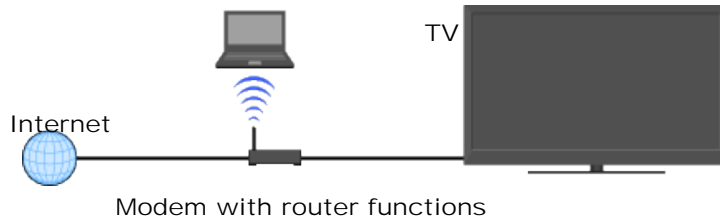

### Network setup for wired LAN

1. Set up your LAN router.
2. Press HOME, then select  → [Network] → [Network Setup].  
The start-up screen appears.
3. Select [Wired Setup] → [Auto] or [Custom].  
[Auto]: Allows automatic configuration of your wired network.  
[Custom]: Allows manual configuration of the IP address and proxy server.
4. Follow the on-screen instructions.



- The setting items (e.g. IP address, subnet mask, DHCP) may vary depending on the Internet service provider or router. For details, refer to the instruction manuals provided by the Internet service provider, or those supplied with the router.

[▲ Return to Top](#)

How to Use i-Manual

“BRAVIA” TV Features

Watching TV

Settings/Home Menu

Using Other  
Equipment/Internet

Parts Description

Troubleshooting

Bookmarks

Index

[➔ i-Manual online map](#)

## USB Auto Start

Enables selection of [Slideshow] or [Thumbnail View] to start photo playback automatically when a USB device is connected.



- Be sure to turn on the TV before connecting a USB device to the TV.

[▲ Return to Top](#)

How to Use i-Manual

“BRAVIA” TV Features

Watching TV

**Settings/Home Menu**

Using Other  
Equipment/Internet

Parts Description

Troubleshooting

Bookmarks

Index

[➡ i-Manual online map](#)

## Refresh Internet Content

---

Reconnects to the Internet to receive available Internet content services.

[▲ Return to Top](#)

How to Use i-Manual

“BRAVIA” TV Features

Watching TV

Settings/Home Menu

Using Other  
Equipment/Internet

Parts Description

Troubleshooting

Bookmarks

Index

[→ i-Manual online map](#)

## Home Network Setup

---

### Show/Hide Media Servers

Displays the connected server list. You can select the server to display in the Home Menu.

---

### Media Server Troubleshooting

Diagnoses whether the TV can connect to each server on the home network.

---

### Remote Device / Renderer

[Remote Device / Renderer]: Enables a mobile device (e.g. smartphone) to work as the TV's remote control via the network, or the TV to play photo/music/video files on a device (e.g. digital still camera) by operating the device via the network.

[Renderer Access Control] : Allows access from a specified control device.

[Renderer Options] : Adjusts the [Renderer Options] detailed settings.

[Auto Access Permission] : Permits access to the TV automatically when a control device accesses the TV for the first time.

[Smart Select] : Responds to infrared signals sent from control devices.

[Renderer Name] : Sets the name of the TV shown on the control device.

---

[Remote Device List]: Lists the registered mobile devices/deregisters the devices.

---

[▲ Return to Top](#)



How to Use i-Manual

“BRAVIA” TV Features

Watching TV

**Settings/Home Menu**

Using Other  
Equipment/Internet

Parts Description

Troubleshooting

Bookmarks

Index

[➡ i-Manual online map](#)

## 3D Settings

---

### Auto 3D

Automatically switches to 3D display mode when a 3D signal is detected.

---

### 3D Signal Notification

Notifies when a 3D signal is detected.

---

[▲ Return to Top](#)

How to Use i-Manual

“BRAVIA” TV Features

Watching TV

Settings/Home Menu

Using Other  
Equipment/Internet

Parts Description

Troubleshooting

Bookmarks

Index

[➔ i-Manual online map](#)

## MTS Audio

---

Sets audio settings for analog programs.

---

### Stereo

Adjusts sound for stereo reception.

---

### Auto SAP

Adjusts sound for second channel audio of programs such as bilingual.

---

### Mono

Adjusts sound for monaural reception.

Use this item when the stereo signal is unstable.



- To select sound on digital channels, press OPTIONS, then select [Alternate Audio].

[▲ Return to Top](#)

How to Use i-Manual

“BRAVIA” TV Features

Watching TV

Settings/Home Menu

Using Other  
Equipment/Internet

Parts Description

Troubleshooting

Bookmarks

Index

[➡ i-Manual online map](#)

## Headphone Speaker Link

---

Switches the TV's internal speakers on or off when you connect headphones to the TV.

[▲ Return to Top](#)

How to Use i-Manual

“BRAVIA” TV Features

Watching TV

Settings/Home Menu

Using Other  
Equipment/Internet

Parts Description

Troubleshooting

Bookmarks

Index

[➔ i-Manual online map](#)

## HDMI/DVI Audio Source

---

Sets the audio signal source for HDMI/DVI input.

---

### Auto

Automatically sets the audio signal source based on the video signal.

---

### HDMI Audio

Sets the HDMI input as the audio signal source.

---

### PC Audio

Sets the PC/HDMI audio input as the audio signal source.

---

[▲ Return to Top](#)

How to Use i-Manual

“BRAVIA” TV Features

Watching TV

Settings/Home Menu

Using Other  
Equipment/Internet

Parts Description

Troubleshooting

Bookmarks

Index

[➔ i-Manual online map](#)

## Key Tone

---

Plays sounds as you navigate with the remote control.

[▲ Return to Top](#)

How to Use i-Manual

“BRAVIA” TV Features

Watching TV

Settings/Home Menu

Using Other  
Equipment/Internet

Parts Description

Troubleshooting

Bookmarks

Index

[→ i-Manual online map](#)

## TV Position

---

Provides different sound images from the TV speakers according to how you position the TV.

---

### Table-Top Stand

Provides the best sound quality when you place the TV on a TV stand.

---

### Wall Mount/Floor Stand

Provides the best sound quality when you hang the TV on a wall or use a floor stand.

---

[▲ Return to Top](#)

How to Use i-Manual

“BRAVIA” TV Features

Watching TV

Settings/Home Menu

Using Other  
Equipment/Internet

Parts Description

Troubleshooting

Bookmarks

Index

[➡ i-Manual online map](#)

## Language

---

Sets the language displayed on the menu screens.

[▲ Return to Top](#)

How to Use i-Manual

“BRAVIA” TV Features

Watching TV

Settings/Home Menu

Using Other  
Equipment/Internet

Parts Description

Troubleshooting

Bookmarks

Index

[➔ i-Manual online map](#)

## Region

---

Enables selection of your location to receive services from Internet content providers as well as Rovi On Screen Guide program data.

[▲ Return to Top](#)



How to Use i-Manual

“BRAVIA” TV Features

Watching TV

Settings/Home Menu

Using Other  
Equipment/Internet

Parts Description

Troubleshooting

Bookmarks

Index

[→ i-Manual online map](#)

## Closed Captions (CC)

---

### CC Display

Displays [Closed Captions (CC)]. Select [On when Muting] to automatically display closed captions when the TV is muted.

---

### Analog CC

Sets the basic analog (EIA-608) closed caption options.

---

### Digital CC

Sets both analog (EIA-608) and digital (EIA-708) closed caption options.

---

### Display Options

Customizes the closed caption appearance.

---

[▲ Return to Top](#)

How to Use i-Manual

“BRAVIA” TV Features

Watching TV

Settings/Home Menu

Using Other  
Equipment/Internet

Parts Description

Troubleshooting

Bookmarks

Index

[➡ i-Manual online map](#)

## Info Banner

---

Sets the amount of information to display about the currently viewed TV channel and program.

[▲ Return to Top](#)

How to Use i-Manual

“BRAVIA” TV Features

Watching TV

**Settings/Home Menu**

Using Other  
Equipment/Internet

Parts Description

Troubleshooting

Bookmarks

Index

[➡ i-Manual online map](#)

## Picture Adjustments Lock

---

Prevents the picture adjustments from being changed.

[▲ Return to Top](#)

How to Use i-Manual

“BRAVIA” TV Features

Watching TV

Settings/Home Menu

Using Other  
Equipment/Internet

Parts Description

Troubleshooting

Bookmarks

Index

[➔ i-Manual online map](#)

## Cable/Antenna

---

Sets the received signal to [Cable] or [Antenna].



- After changing this setting, it is recommended to run [Auto Program].

[▲ Return to Top](#)

How to Use i-Manual

“BRAVIA” TV Features

Watching TV

Settings/Home Menu

Using Other  
Equipment/Internet

Parts Description

Troubleshooting

Bookmarks

Index

[➔ i-Manual online map](#)

## Add Digital Channels

---

Adds digital channels.

Be sure to have the signal type option selected appropriately for the signal source.

[▲ Return to Top](#)

How to Use i-Manual

“BRAVIA” TV Features

Watching TV

Settings/Home Menu

Using Other  
Equipment/Internet

Parts Description

Troubleshooting

Bookmarks

Index

[➔ i-Manual online map](#)

## Show/Hide Channels

---

Shows or hides channels when you surf with CH +/- or in the channel list of [TV Channel List] under  [TV] in the Home Menu.

[▲ Return to Top](#)

How to Use i-Manual

“BRAVIA” TV Features

Watching TV

**Settings/Home Menu**

Using Other  
Equipment/Internet

Parts Description

Troubleshooting

Bookmarks

Index

[➔ i-Manual online map](#)

## Edit Channel Labels

---

Edit channel labels to your preference.

[▲ Return to Top](#)

How to Use i-Manual

“BRAVIA” TV Features

Watching TV

**Settings/Home Menu**

Using Other  
Equipment/Internet

Parts Description

Troubleshooting

Bookmarks

Index

[➡ i-Manual online map](#)

## Program Information Source

---

Selects a source to receive program information.

[▲ Return to Top](#)



How to Use i-Manual

“BRAVIA” TV Features

Watching TV

Settings/Home Menu

Using Other  
Equipment/Internet

Parts Description

Troubleshooting

Bookmarks

Index

[➔ i-Manual online map](#)

## Analog Fine Tune

---

Allows you to fine-tune analog channels to adjust picture quality.

---

### Auto

Tunes channel automatically.

---

### Custom

Tunes channel manually.

---

[▲ Return to Top](#)

How to Use i-Manual

“BRAVIA” TV Features

Watching TV

Settings/Home Menu

Using Other  
Equipment/Internet

Parts Description

Troubleshooting

Bookmarks

Index

[→ i-Manual online map](#)

## HDMI Settings

Communicates with equipment compatible with the “Control for HDMI” function.



- [Control for HDMI] settings must be made on the connected equipment.

### Control for HDMI

Links the operations of the TV and the connected equipment.

For specific Sony equipment compatible with “Control for HDMI,” this setting is applied automatically to the connected equipment when [On] is set.

### Device Auto Power Off

Turns off the connected equipment when you turn off the TV.

### TV Auto Power On

Turns on the TV when you turn on or perform playback, etc., on the connected equipment.

### Device List

Displays a list of connected equipment compatible with “Control for HDMI.”

### Device Control Keys

Operates the connected equipment by the TV’s remote control.

[None] : Turns off [Device Control Keys].

[Normal] : Enables basic operations, such as navigation buttons (up, down, left or right, etc.).

[Tuning Keys] : Enables basic operations and operation of channel-related buttons, such as CH +/- or 0 - 9, etc.

Useful when you control a tuner or set-top box, etc., via the remote control.

[Menu Keys] : Enables basic operations and operation of HOME/OPTIONS.

Useful when you select menus of a BD player, etc., via the remote control.

[Tuning and Menu Keys] : Enables basic operations and operation of HOME/OPTIONS and channel-related buttons.

[▲ Return to Top](#)

How to Use i-Manual

“BRAVIA” TV Features

Watching TV

Settings/Home Menu

Using Other  
Equipment/Internet

Parts Description

Troubleshooting

Bookmarks

Index

[→ i-Manual online map](#)

## Network Setup

---

### View Network Status

Displays the network status and settings.

---

### Wired Setup

[Auto]: Allows automatic configuration of your wired network.

[Custom]: Allows manual configuration of your wired network by setting the following items.

---

#### IP Address Setting

[Auto]: Sets the IP address automatically.

[Manual]: Allows manual configuration of the IP address as follows.

[IP Address]/[Subnet Mask]/[Default Gateway]/[Primary DNS]/[Secondary DNS]: Configures your network options.

---

#### Proxy Server

Sets the proxy server name and port number if a proxy server is used.

---

### Wireless Setup

Allows configuration of your wireless network.

For details, see the information on wireless LAN in “Internet/Wireless LAN” in this manual.

---

[▲ Return to Top](#)

How to Use i-Manual

“BRAVIA” TV Features

Watching TV

**Settings/Home Menu**

Using Other  
Equipment/Internet

Parts Description

Troubleshooting

Bookmarks

Index

[➡ i-Manual online map](#)

## Contact Sony

---

Displays Sony contact information for your convenience. TV-specific information such as model name, serial number, software version and downloadable ratings (if available from the TV) are also displayed.

[▲ Return to Top](#)

How to Use i-Manual

“BRAVIA” TV Features

Watching TV

**Settings/Home Menu**

Using Other  
Equipment/Internet

Parts Description

Troubleshooting

Bookmarks

Index

[→ i-Manual online map](#)

## Signal Diagnostics

---

Displays the diagnostics information for the current signal.

[▲ Return to Top](#)

How to Use i-Manual

“BRAVIA” TV Features

Watching TV

Settings/Home Menu

Using Other  
Equipment/Internet

Parts Description

Troubleshooting

Bookmarks

Index

[⇒ i-Manual online map](#)

## Automatic Software Download

Downloads the TV software automatically via your existing antenna/cable/Internet (if available).  
After the download is complete, a confirmation message about starting an update appears when you turn on the TV.



- [Automatic Software Download] via the Internet is available only on certain TV models.
- The software is downloaded when the TV is in standby mode.

[▲ Return to Top](#)

How to Use i-Manual

“BRAVIA” TV Features

Watching TV

Settings/Home Menu

Using Other  
Equipment/Internet

Parts Description

Troubleshooting

Bookmarks

Index

[→ i-Manual online map](#)

## Software Update

---

Updates the TV's software.

A confirmation message about starting an update appears.

If no software has been downloaded , the TV will start searching for an update via the Internet (if connected).

[▲ Return to Top](#)

How to Use i-Manual

"BRAVIA" TV Features

Watching TV

Settings/Home Menu

Using Other  
Equipment/Internet

Parts Description

Troubleshooting

Bookmarks

Index

[→ i-Manual online map](#)

## Viewing from HDMI Equipment

1. Turn on the connected equipment.
2. Press INPUT, then select the desired input source.



[▲ Return to Top](#)



How to Use i-Manual

"BRAVIA" TV Features

Watching TV

Settings/Home Menu

Using Other  
Equipment/Internet

Parts Description

Troubleshooting

Bookmarks

Index

[→ i-Manual online map](#)

## "BRAVIA" Sync with "Control for HDMI"

With the "Control for HDMI" function, "BRAVIA" Sync helps communicate with "BRAVIA" Sync-compatible equipment using HDMI CEC (Consumer Electronics Control).

### Activating "Control for HDMI" ("BRAVIA" Sync)

1. Press HOME, then select → [Channels & Inputs] → [HDMI Settings] → [Control for HDMI] → [On].
2. Activate "Control for HDMI" on the connected equipment.  
For details, refer to the instruction manual of the connected equipment.



- "Control for HDMI" ("BRAVIA" Sync) is only available for the connected Sony equipment that has the "BRAVIA" Sync logo or is compatible with "Control for HDMI."
- When specific Sony equipment compatible with "Control for HDMI" ("BRAVIA" Sync) is connected and powered on, and [Control for HDMI] is set to [On], "BRAVIA" Sync is automatically activated on the equipment.

## Available "BRAVIA" Sync operations

### BD/DVD player

- Automatically turns the "BRAVIA" Sync-compatible equipment on and switches the input to that equipment when you select it from the Home Menu or Sync Menu.
- Automatically turns the TV on and switches the input to the connected equipment when the equipment starts to play.
- Automatically turns the connected equipment off when you turn the TV off.
- Controls menu operation (, , , ), playback (e.g. , ) and channel selection of the connected equipment through the TV's remote control.

### AV amplifier

- Automatically turns the connected AV amplifier on and switches the sound output from the TV speaker to the audio system when you turn the TV on. This function is only available if you have previously used the AV amplifier to output TV sound.
- Automatically switches the sound output to the AV amplifier by turning the AV amplifier on when the TV is turned on.
- Automatically turns the connected AV amplifier off when you turn the TV off.
- Adjusts the volume (VOL +/-) and mutes the sound (MUTING) of the connected AV amplifier through the TV's remote control.



- When connecting a digital audio system that is compatible with Audio Return Channel (ARC) technology, connect to HDMI IN 1 with an HDMI cable. If connecting a system that is incompatible with "Control for HDMI" or Audio Return Channel, an additional audio

connection via DIGITAL AUDIO OUT (OPTICAL) is necessary.

## Video camera

- Automatically turns the TV on and switches the input to the connected video camera when the connected video camera is turned on.
- Automatically turns the connected video camera off when you turn the TV off.
- Controls menu operation (◀/▶/▲/▼), playback (e.g. ▶, ■) and channel selection of the connected equipment through the TV's remote control.

## Controlling "BRAVIA" Sync-compatible equipment

You can control "BRAVIA" Sync-compatible equipment by the TV's remote control.  
Press SYNC MENU, then select [HDMI Device Selection] → the desired equipment.

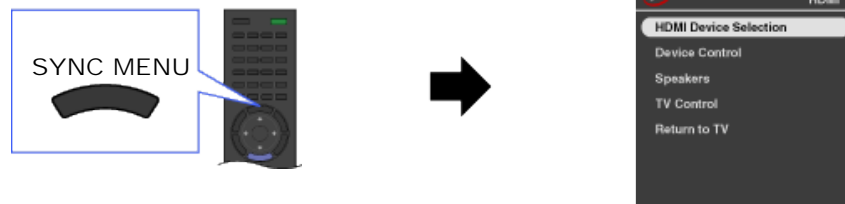

- Any "BRAVIA" Sync-compatible equipment (except audio system) is listed as a new input source under [Inputs] in the Home Menu.

## Sync Menu

Sync Menu provides the following items.

Press SYNC MENU, then select the desired item.

### HDMI Device Selection

Enables selection of "BRAVIA" Sync-compatible equipment to control by the TV's remote control.

### Device Control

Displays the menu, options and title list of the connected equipment, or turns the equipment off.

### Speakers

Switches the speaker output between the TV and connected audio equipment.

### TV Control

Displays the menu and options of the TV, or shows/hides the display items on the TV screen.

### Return to TV

Returns to the TV tuner.

[▲ Return to Top](#)

- How to Use i-Manual
- "BRAVIA" TV Features
- Watching TV
- Settings/Home Menu
- Using Other Equipment/Internet
- Parts Description
- Troubleshooting
- Bookmarks
- Index

[→ i-Manual online map](#)

## Wireless LAN Ready

By inserting the USB Wireless LAN Adapter UWA-BR100 (as of December 2010) into your TV's USB port, you can create a wireless network connection.

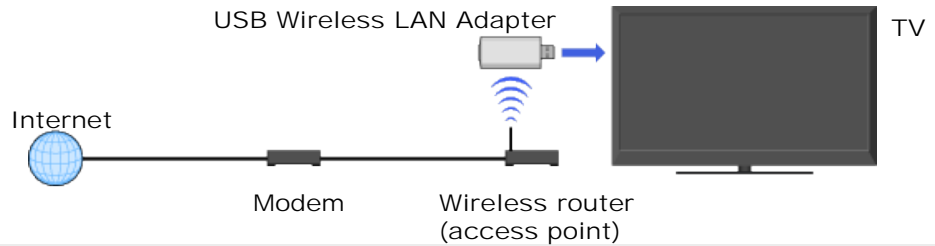

- The USB Wireless LAN Adapter is supplied or available as an optional accessory, depending on your TV model. In some regions/countries, the USB Wireless LAN Adapter may not be available.
- If your TV has two USB ports, be sure to connect the USB Wireless LAN Adapter to the upper USB port.

## Connecting to your wireless LAN

1. Set up your wireless router (or access point).  
For details, refer to the instruction manual of your wireless router (or access point).
2. Check your wireless LAN environment using the following chart.



- Tip for smooth video streaming: Change the setting of your wireless router (or access point) to 802.11n and 5GHz if possible. For details on how to change the setting, refer to the instruction manual of your wireless router (or access point).

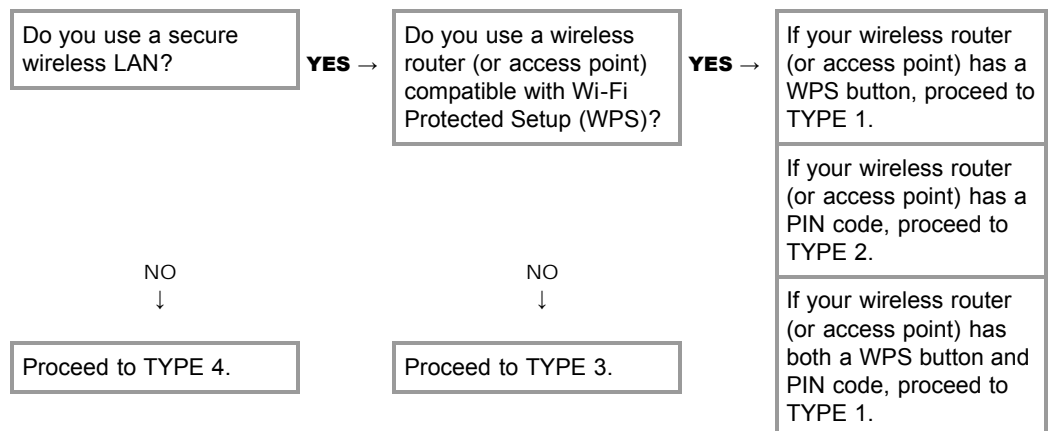

## TYPE 1: Secured network using the WPS button

---

1. Check the WPS button location on your wireless router (or access point) and verify how to use it.
2. Press HOME, then select  → [Network] → [Network Setup].  
The start-up screen appears.
3. Select [Wireless Setup] → [WPS (Push Button)], then follow the on-screen instructions.

## TYPE 2: Secured network using the PIN code

---

1. Press HOME, then select  → [Network] → [Network Setup].  
The start-up screen appears.
2. Select [Wireless Setup] → [WPS (PIN)], then follow the on-screen instructions.

## TYPE 3: Secured network using SSID and security key

---

1. Check the SSID (wireless network name) and security key (WEP or WPA key) of your wireless router (or access point).  
If you do not know them, refer to the instruction manual of your wireless router (or access point).
2. Press HOME, then select  → [Network] → [Network Setup].  
The start-up screen appears.
3. Select [Wireless Setup] → [Scan].
4. Select a network from the list of scanned wireless networks, then follow the on-screen instructions.

## TYPE 4: Unsecured network using only SSID

---

1. Check the SSID (wireless network name).  
If you do not know the SSID, refer to the instruction manual of your wireless router (or access point).
2. Press HOME, then select  → [Network] → [Network Setup].  
The start-up screen appears.
3. Select [Wireless Setup] → [Scan].
4. Select a network from the list of scanned wireless networks, then follow the on-screen instructions.

[▲ Return to Top](#)

How to Use i-Manual

"BRAVIA" TV Features

Watching TV

Settings/Home Menu

Using Other  
Equipment/Internet

Parts Description

Troubleshooting

Bookmarks

Index

[→ i-Manual online map](#)

## Browsing Websites

With the TV connected to the Internet, you can browse websites.

1. Make a broadband Internet connection.  
For details, see the information on wireless/wired LAN in "Internet/Wireless LAN" in this manual.
2. Press HOME, then select  → [Internet Browser].

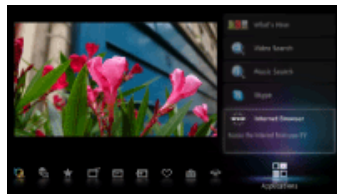

- Web content may not be displayed correctly, or some functions may not work properly, if the TV does not support the functions provided by certain Internet services. Also, the TV may not support functions developed in the future.

### Note on Internet browser

In no event shall Sony be liable for any damage caused or associated with the use of the Internet browser, malfunction (including software) or communication failure.

[▲ Return to Top](#)

How to Use i-Manual

"BRAVIA" TV Features

Watching TV

Settings/Home Menu

Using Other  
Equipment/Internet

Parts Description

Troubleshooting

Bookmarks

Index

→ i-Manual online map

## "BRAVIA" Internet Video

This feature serves as a gateway to Internet content, delivering a variety of on-demand entertainment straight to your TV. You can enjoy video content, including movies and cartoons.

1. Make a broadband Internet connection.  
For details, see the information on wireless/wired LAN in "Internet/Wireless LAN" in this manual.
2. Press INTERNET VIDEO, then select [BRAVIA Internet Video] → the desired service.

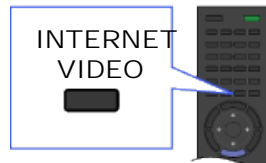

3. Highlight the desired content, then press .



- If you experience difficulties with this feature, check that the Internet connection is set up properly.
- Information about the highlighted icon appears in the information banner.
- The interface to Internet content depends on the Internet content providers.
- Services block video content based on the [Parental Lock] setting of the TV. Some service providers do not support this function.
- To update "BRAVIA" Internet Video content services, press HOME, then select  → [Network] → [Refresh Internet Content].

## Seeking forward/backward in video content

Press the buttons on the remote control that correspond with the control indications on the screen.



Control indications

▲ Return to Top



How to Use i-Manual

"BRAVIA" TV Features

Watching TV

Settings/Home Menu

Using Other  
Equipment/Internet

Parts Description

Troubleshooting

Bookmarks

Index



→ i-Manual online map

## Photomap

By connecting a digital still camera with GPS function, you can display a photo with a map of the location where the photo was taken.

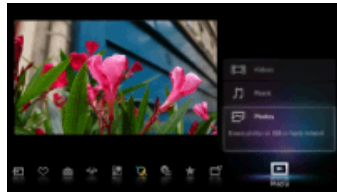
Press HOME, then select  → [Photos] → the connected device → the desired photo.



- To use this feature, the TV has to be connected to the Internet to download map information.
- To zoom in/out the map, press /.
- To change the display position of the map, press the far left color button repeatedly.
- Only a large-scale map that cannot be zoomed in or out is displayed if the TV is not connected to the Internet or the online map service is terminated.
- The position indicated on the map may differ depending on the image capture device.
- The Internet online map service is provided by a third party. For this reason, service may be changed or terminated without prior notification.

 Return to Top



How to Use i-Manual

"BRAVIA" TV Features

Watching TV

Settings/Home Menu

Using Other  
Equipment/Internet

Parts Description

Troubleshooting

Bookmarks

Index

[→ i-Manual online map](#)

## What's New

---

This feature allows you to check for new content available on your TV that is delivered by various service providers.

Press HOME, then select  → [What's New] → the desired item.



- To use this feature, the TV has to be connected to the Internet.
- If you select to receive notification alerts from [What's New], you will be prompted whenever there is an update.

[▲ Return to Top](#)

How to Use i-Manual

"BRAVIA" TV Features

Watching TV

Settings/Home Menu

Using Other  
Equipment/Internet

Parts Description

Troubleshooting

Bookmarks

Index

[→ i-Manual online map](#)

## Renderer

You can play back photo, music and video files stored in network devices (e.g. digital still cameras, mobile phones, PC) on the TV screen by directly operating the target device. The network device should also be renderer-compatible.

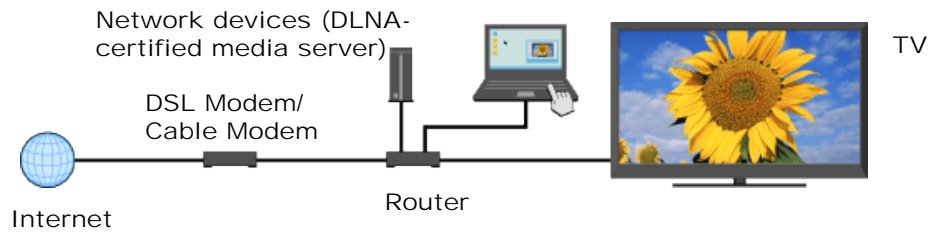

## Adjusting the renderer settings

Press HOME, then select → [Network] → [Home Network Setup] → [Renderer] → the desired setting.

[▲ Return to Top](#)

How to Use i-Manual

“BRAVIA” TV Features

Watching TV

Settings/Home Menu

Using Other  
Equipment/Internet

Parts Description

Troubleshooting

Bookmarks

Index

[➡ i-Manual online map](#)

## Display Settings for Media Servers

---

Select home network servers to be displayed in the Home Menu. Up to 10 servers can be displayed in the Home Menu automatically.

1. Press HOME, then select  → [Network] → [Home Network Setup] → [Show/Hide Media Servers].
2. Select the server to display in the Home Menu.

[▲ Return to Top](#)

How to Use i-Manual

“BRAVIA” TV Features

Watching TV

Settings/Home Menu

Using Other  
Equipment/Internet

Parts Description

Troubleshooting

Bookmarks

Index

[➡ i-Manual online map](#)

## Media Server Troubleshooting

---

The TV checks if the server is being correctly recognized when you cannot connect it to your home network. If the diagnostic results indicate a failure, check possible causes, and network connections and settings.

Press HOME, then select  → [Network] → [Home Network Setup] → [Media Server Troubleshooting].

The diagnostic result list appears when the server diagnostic is complete.

[▲ Return to Top](#)